

UNITED STATES DEPARTMENT OF THE INTERIOR
GEOLOGICAL SURVEY

USGS FM CASSETTE SEISMIC-REFRACTION RECORDING SYSTEM

by

J. M. MURPHY

Prepared by the

U.S. GEOLOGICAL SURVEY

for the

NEVADA OPERATIONS OFFICE

U.S. DEPARTMENT OF ENERGY

(Interagency Agreement DE-AI08-78ET44802)



OPEN-FILE REPORT 88-570

This report is preliminary and has not been reviewed for conformity with U.S. Geological Survey editorial standards. Any use of trade, product or firm names is for descriptive purposes only and does not imply endorsement by the U.S. Government.

Menlo Park, California

1989

UNITED STATES DEPARTMENT OF THE INTERIOR
GEOLOGICAL SURVEY

USGS FM Cassette Seismic-Refraction Recording System

J. M. Murphy¹

Open-File Report 88-570

This report is preliminary and has not been reviewed for conformity with U.S. Geological Survey editorial standards. Any use of trade, product or firm names is for descriptive purposes only and does not imply endorsement by the U.S. Government.

1. USGS, Menlo Park, California

1988

TABLE OF CONTENTS

	Page
Abstract.....	1
Chapter 1 Seismic-Refracton Data Acquisition System	
1.0 Introduction.....	2
1.1 Recording Unit.....	7
1.2 Digitizing Unit.....	10
1.3 System Response.....	12
1.4 Diagnostics and Calibration.....	18
1.5 Time Code.....	20
Chapter 1 Figures	
1.1 Schematic diagram of the data aquisition and processing system.....	3
1.2 Picture of the Recording Unit.....	4
1.3 Schematic diagram of the recording sequence.....	5
1.4 Picture of the Digitizing Unit.....	6
1.5 Block diagram of the recording unit circuit boards.....	8
1.6 Block diagram of the amplifier/VCO board.....	9
1.7 Block diagram of the digitizing unit.....	11
1.8 Time code parallel transmission word format.....	13
1.9 Amplitude-response curve.....	17
1.10 Diagnostic and calibration sequence.....	19
1.11 IRIG-E time code.....	21
Chapter 1 Tables	
1.1 Component parameters of the recording and digitizing system.....	15
1.2 Amplitude response values for the major components of the data acquisition system.....	16
1.3 Gain values for selected attenuation settings.....	16
1.4 Manufacturers of the major components.....	22
Chapter 2 Seismic Cassette Recorder Users Guide	
2.1 Introduction.....	24
2.2 Defintions and general information.....	24
2.2.1 Recording parameters.....	24
2.2.2 Batteries.....	29
2.2.3 SCR.....	30
2.2.4 Field notes.....	30
2.2.5 Past disasters and how to avoid them.....	33
2.3 Description of HHT and SCR controls.....	33
2.3.1 HHT.....	33
2.3.2 SCR.....	35

2.4	Programming procedures before deployment.....	38
2.4.1	Programming the HHT.....	38
2.4.1.1	Memory.....	38
2.4.1.2	Synchronizing the internal clock.....	38
2.4.2	Programming the SCR.....	39
2.4.2.1	Memory.....	40
2.4.2.2	Synchronizing the internal clock.....	40
2.4.2.3	Attenuations and cassette tape.....	40
2.4.3	Charging the SCR batteries.....	41
2.5	Procedure after retrieval of the SCRs.....	41
2.5.1	Recording drift times.....	41
2.6	Miscellaneous HHT features.....	41
 Chapter 2 Figures		
2.1	Schematic diagram of the recording sequence.....	25
2.2	Schematic diagram of the extended recording sequence.....	28
2.3	Schematic diagram of the resistor bank.....	29
2.4	Seismic cassette recorder (SCR).....	30
2.5	Recorder field data sheet.....	31
2.6	Deployment timing check list.....	32
2.7	HHT front panel.....	34
2.8	SCR user interface.....	37
 Chapter 2 Tables		
2.1	Seismic window lengths.....	27
2.2	Program window examples.....	27
2.3	HHT monitor switch positions.....	37
 Acknowledgments.....		
		42
References.....		
		43
Appendix A : Example of time code.....		
		A-1

ABSTRACT

In this two chapter report, instrumentation used to collect seismic data is described. This data acquisition system has two parts: 1) portable analog seismic recorders and related "Hand-held-testers" (HHT) and 2) portable digitizing units. During the analog recording process, ground motion is sensed by a 2-Hz vertical-component seismometer. The voltage output from the seismometer is split without amplification and sent to three parallel amplifier circuit boards. Each circuit board amplifies the seismic signal in three stages and then frequency modulates the signal. Amplification at the last two stages can be set by the user. An internal precision clock signal is also frequency modulated. The three data carrier frequencies, the clock carrier frequency, and a tape-speed compensation carrier frequency are summed and recorded on a cassette tape. During the digitizing process, the cassette tapes are played back and the signals are demultiplexed and demodulated. An analog-to-digital converter converts the signals to digital data which are stored on 8-inch floppy disks. The complete system response is roughly flat between 2 and 30 Hz and the approximate ground motion is given by

$$A_g(t) = \frac{A(t)}{R_{GLE} R_{SA} R_{VCO} D_{DSC} D_{ADC}} = \frac{A(t)}{(409.6) R_{SA}}$$

where $A(t)$ is the amplitude response and R_{GLE} , R_{SA} , R_{VCO} , D_{DSC} , and D_{ADC} are the amplitude factors of the major components. The recording unit also performs and records a series of diagnostic tests and calibrations prior to each separate seismic window. The calibrations provide a complete system calibration scheme and are used to verify the actual gain of each data channel and the operation of the seismometer.

Programming a seismic recording unit requires 1) setting channel attenuations, 2) synchronizing the seismic recorder's internal clock with a time standard such as a master clock, and 3) programming the internal logic to turn on the seismic recorder at predetermined times. The HHT performs two of these functions during programming — adjusting the seismic recorder's internal clock and setting the seismic recorder's internal logic. Attenuation is set manually with front-panel knobs. After the seismic recorders are retrieved, their internal clock "drift rates" are recorded on data sheets. Drift rates for both the HHT and the seismic recorders are entered into the computer and clock-drift corrections are made to the data during data processing.

Chapter 1: Seismic-Refraction Data Acquisition System.

INTRODUCTION

The U. S. Geological Survey seismic refraction group in Menlo Park, CA, has operated a portable seismic-refraction data acquisition system since 1978. This system is used primarily to collect seismic refraction data, but also has been used to collect wide-angle and near vertical reflection data, time term data, tomographic data, and microearthquake data. The system has two parts: 1) 120 portable analog seismic recorders and 2) 3 portable digitizing units. A schematic of the complete system (recorder and digitizer) is shown in Figure 1.1. John Van Schaack, Gray Jensen, and Robert McClearn, all of the USGS, designed and built the instrumentation in 1978. Healy et al. (1982) describe acquiring, processing, and interpreting the seismic data collected with this instrumentation.

Each recording unit is approximately 1 cubic foot (0.03 m^3) in volume and weighs 50 lbs (23 kg) (Figure 1.2). Power is provided by two rechargeable 6 volt Gel-Cell batteries contained within the unit. Ground velocity is sensed with a 2-Hz vertical-component seismometer, and data are recorded on a 30-minute 1/4-inch data-quality analog cassette tape. Recording is initiated by internal logic which has ten programmable data windows and is accessed through a 48-pin connector. An external device-- a "hand-held tester" (HHT)-- is used to program the recording unit. A description of programming with the HHT is given in chapter 2.

The counter circuit turns on the recording unit nine minutes, fifty-four seconds before recording seismic data, allowing it to stabilize. One minute and sixteen seconds before recording seismic data the, the recording unit performs and records diagnostic tests and calibration signals. Seismic data window lengths are programmable and determined by the function $2(N)$ minutes minus 54 seconds, where N is an integer between 1 and 7. Hence, the maximum seismic recording window is 13 minutes, 6 seconds and the total recording time, including diagnostic tests and calibration signals, is 14 minutes, 22 seconds. Figure 1.3 displays the recording sequence schematically.

After data acquisition, cassette tapes are played back through the digitizing unit (Figure 1.4) which demultiplexes, demodulates, and digitizes the data. Digitized data are formatted and written to 8-inch floppy disks. The digitizer is comprised of several discrete components manufactured by commercial vendors. All the major component-manufacturers along with their specification manuals are listed in Table 1.4.

This chapter describes the major components of the cassette recorders and the digitizing units and describes the signal response of the complete system. Explanations of the diagnostic tests, calibration signals and the time code are included for completeness.

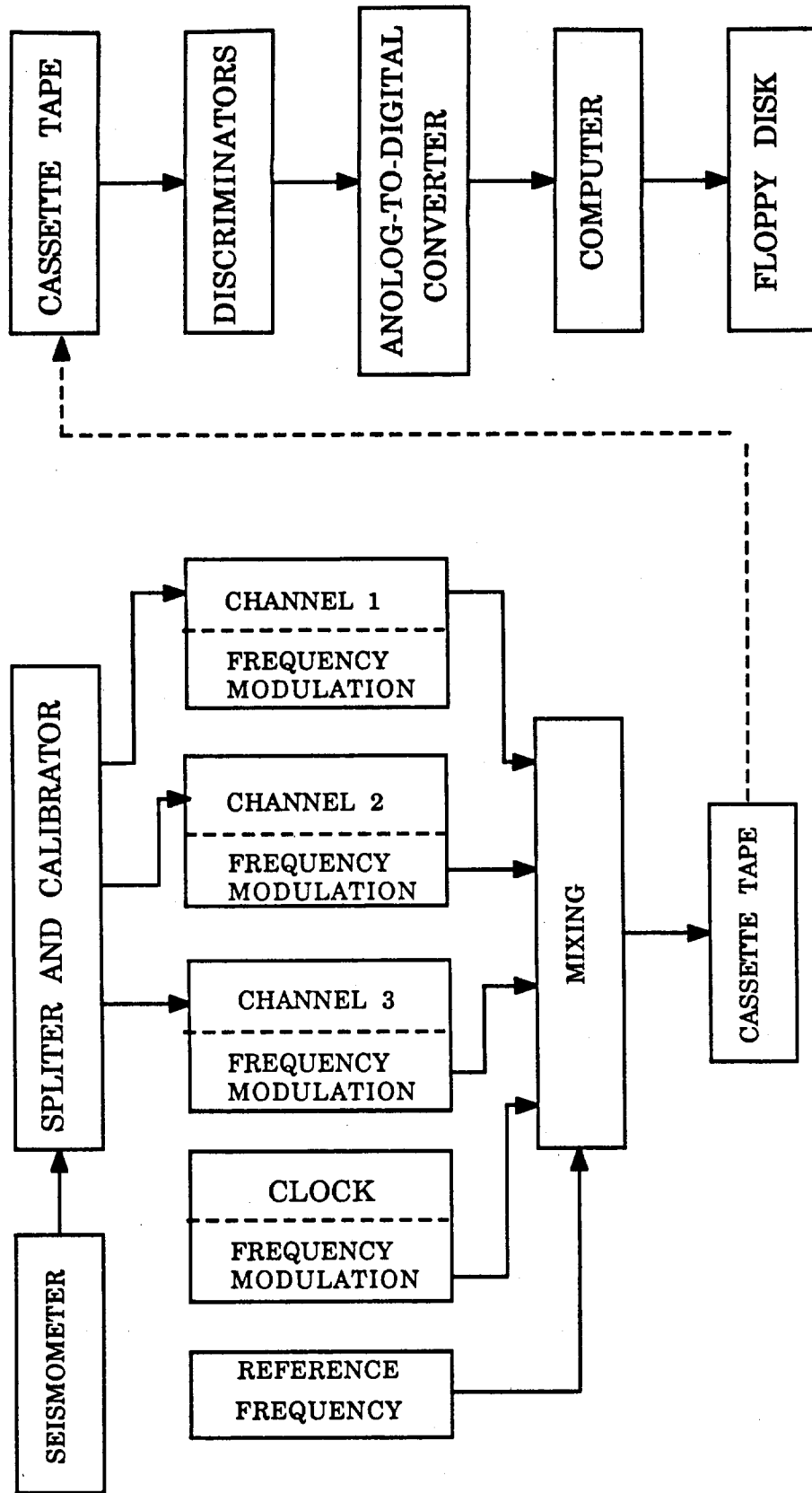

Figure 1.1 Schematic of the data acquisition and processing system.

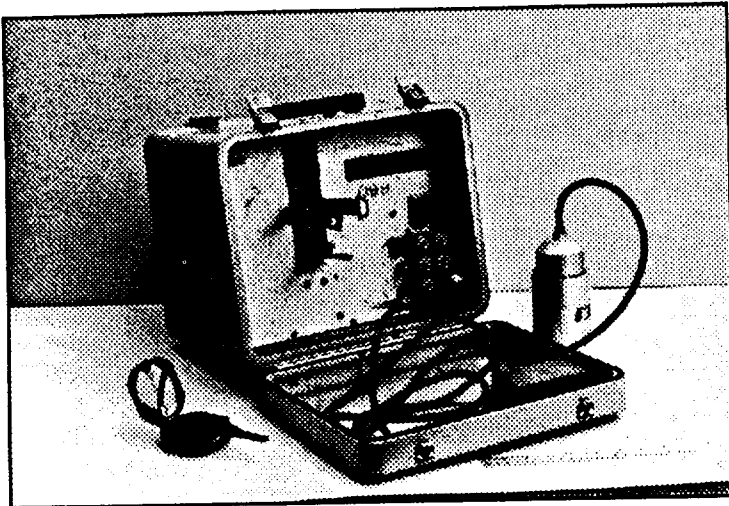
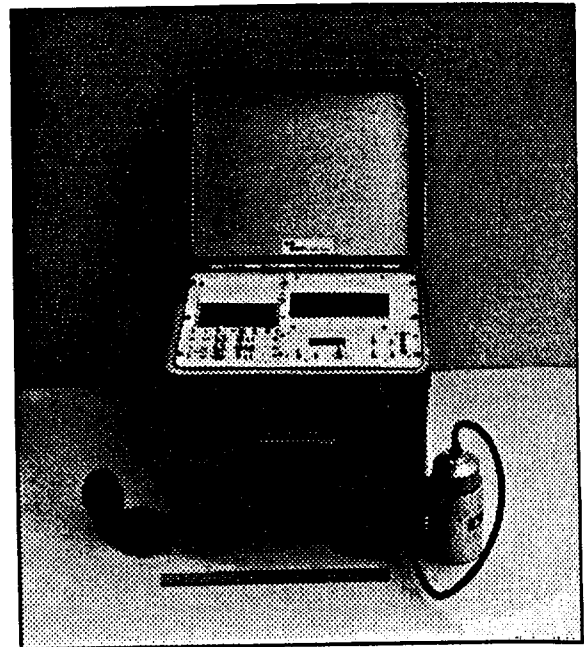
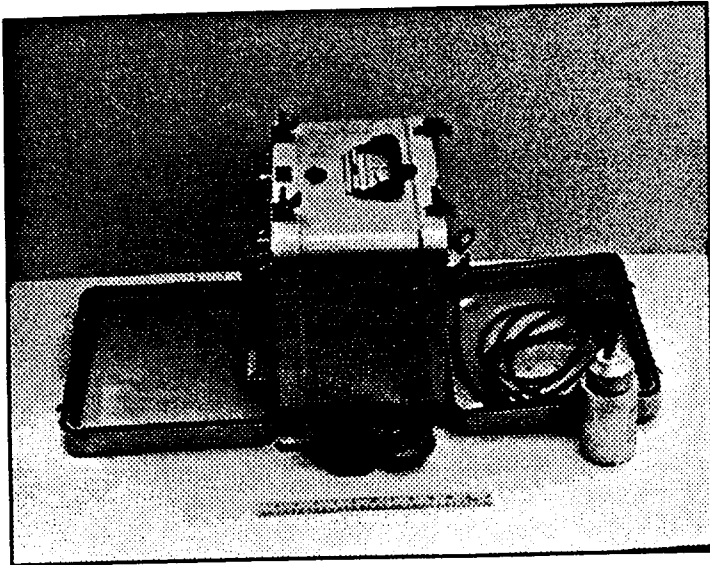

Figure 1.2. Recording unit.

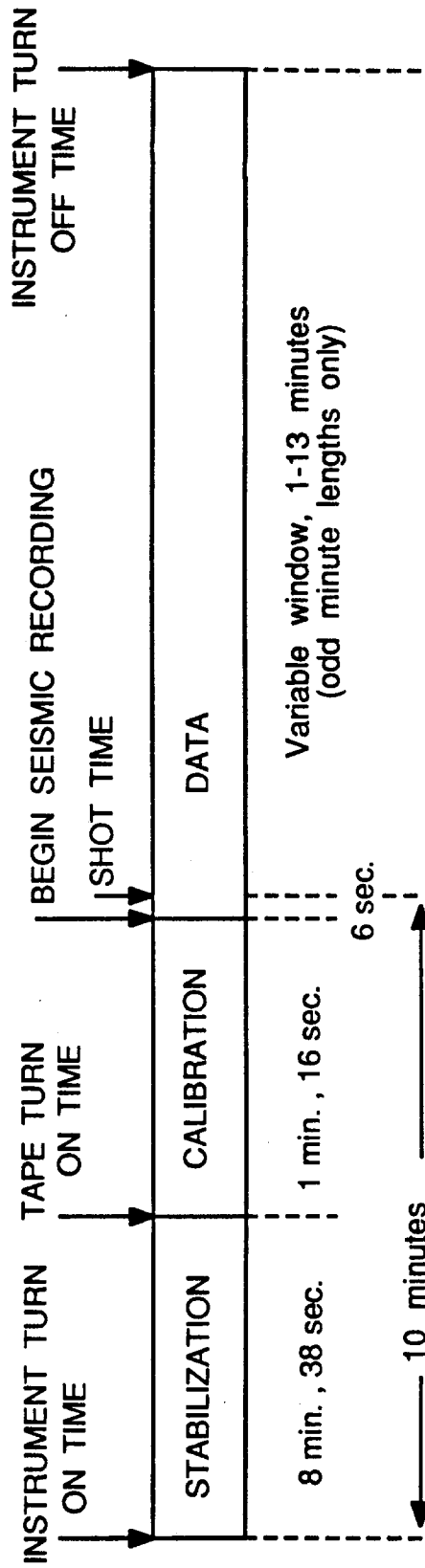

Figure 1.3. Schematic diagram of the recording sequence.
 Note: When recording seismic retraction data, the instruments are normally turned on ten minutes prior to shot time.

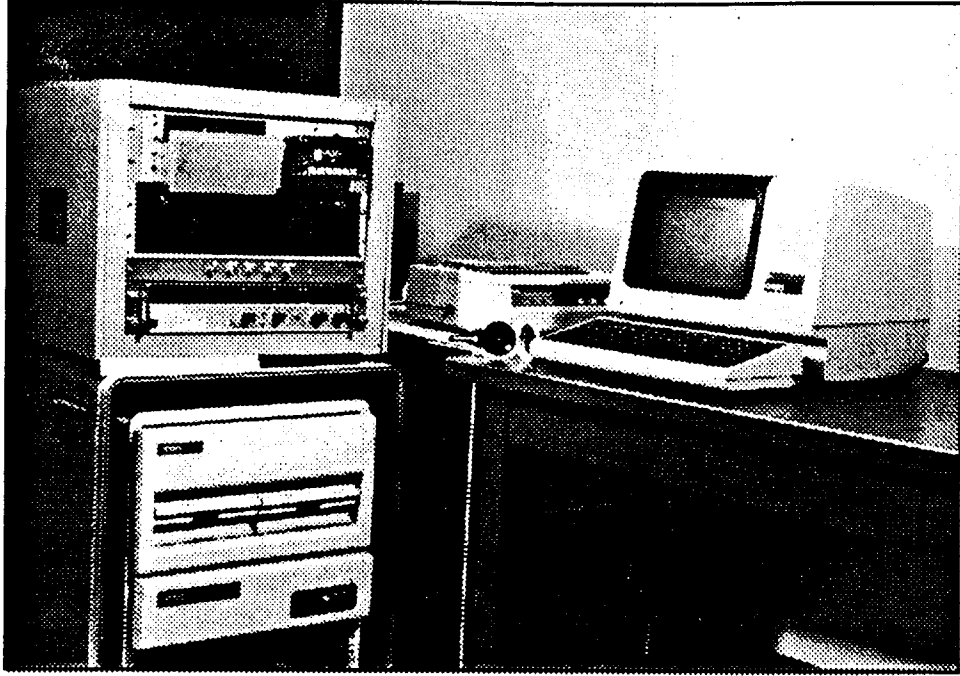

Figure 1.4. Digitizing unit.

RECORDING UNIT

The recording unit (Figure 1.2) is divided into three compartments--two outer operator-accessible areas and an inner compartment where the electronics (Figure 1.5) are housed. A detachable externally deployed seismometer is housed in one of the two outer compartments along with seismometer connectors, a battery recharger connector, and a 48-pin internal logic interface. On the opposite side of the instrument, the other accessible compartment contains the tape deck port, a clock readout (LED), switches for setting and adjusting the clock, and a set of attenuation switches for each of the three data channels. Manual attenuation of a set gain was the traditional manner of recording explosive source data. Following this tradition, the recording units were designed to amplify the signal by 102 db and switches are used to attenuate the signal to a specific amplification. The seismic signal recorded is affected mainly by the seismometer, the amplifier, and the voltage controlled oscillator; each of these components is described below.

For each recorder, ground motion is detected by a single Mark ProductsTM L-4A 2.0-Hz (+ 0.25 Hz) vertical-component seismometer (Table 1.4). The seismometer is coupled to the amplifier board by an L-pad resistor network, which adjusts the effective generator constant to a nominal 1 volt per cm/sec, while providing the proper external damping resistance. The seismometer is damped at 0.8 critical (nominal). A more detailed description of the seismometer and L-pad system is given in Eaton (1975).

The output from the seismometer and L-pad system is split without amplification by a buffer and sent to three amplifier circuit boards (called "channels"). Each channel has three stages of amplification, with maximum amplifications of 12 db, 50 db, and 40 db, respectively (Figure 1.6). Thus, the total gain of the system with the attenuation set to zero is 102 db. Attenuations may be selected at both stage 2 and stage 3. A manual switch ranging from 0 to 54 db, in 6 db increments, controls attenuation at stage 2. At stage 3, attenuation of 0, 20 db, or 40 db is selected with a second switch. The total gain of each channel is the sum of the gains of each stage, where the gain at each stage is the maximum gain minus the attenuation. For example, a channel with an attenuation setting of 48 db at stage 2 and an attenuation setting of 20 db at stage 3 would have a total gain of 34 db.

$$\begin{array}{rcccc} \text{stage 1} & \text{stage 2} & \text{stage 3} & \text{total} & \\ 12 \text{ db} & + [50-48] \text{ db} & + [40-20] \text{ db} & = & 34 \text{ db} \end{array}$$

The total gain of any channel can be derived from the calibration signals recorded after the instrument stabilization period and before the seismic data. These calibration signals are discussed in the diagnostics and calibration section.

After amplification the signal is converted from voltage to frequency (frequency modulation) by a voltage controlled oscillator (VCO). Center frequencies for channels 1, 2, and 3 are 680 Hz, 1020 Hz, and 1360 Hz, respectively. For a maximum voltage deviation of + 5 volts, the maximum

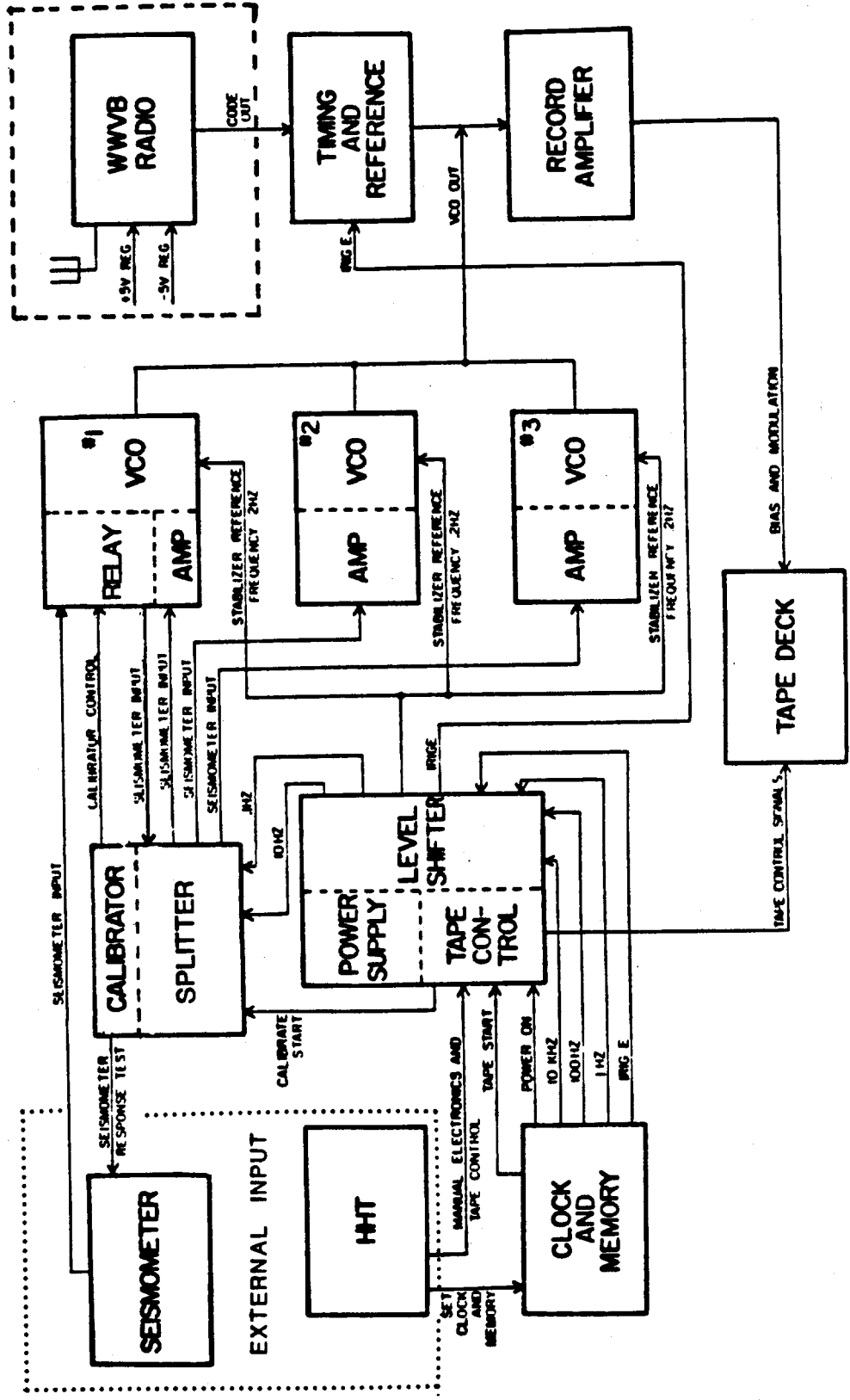

Figure 1.5. Block diagram of the recording unit electronics. WWVB was removed from the recording unit (ca. march, 1984).

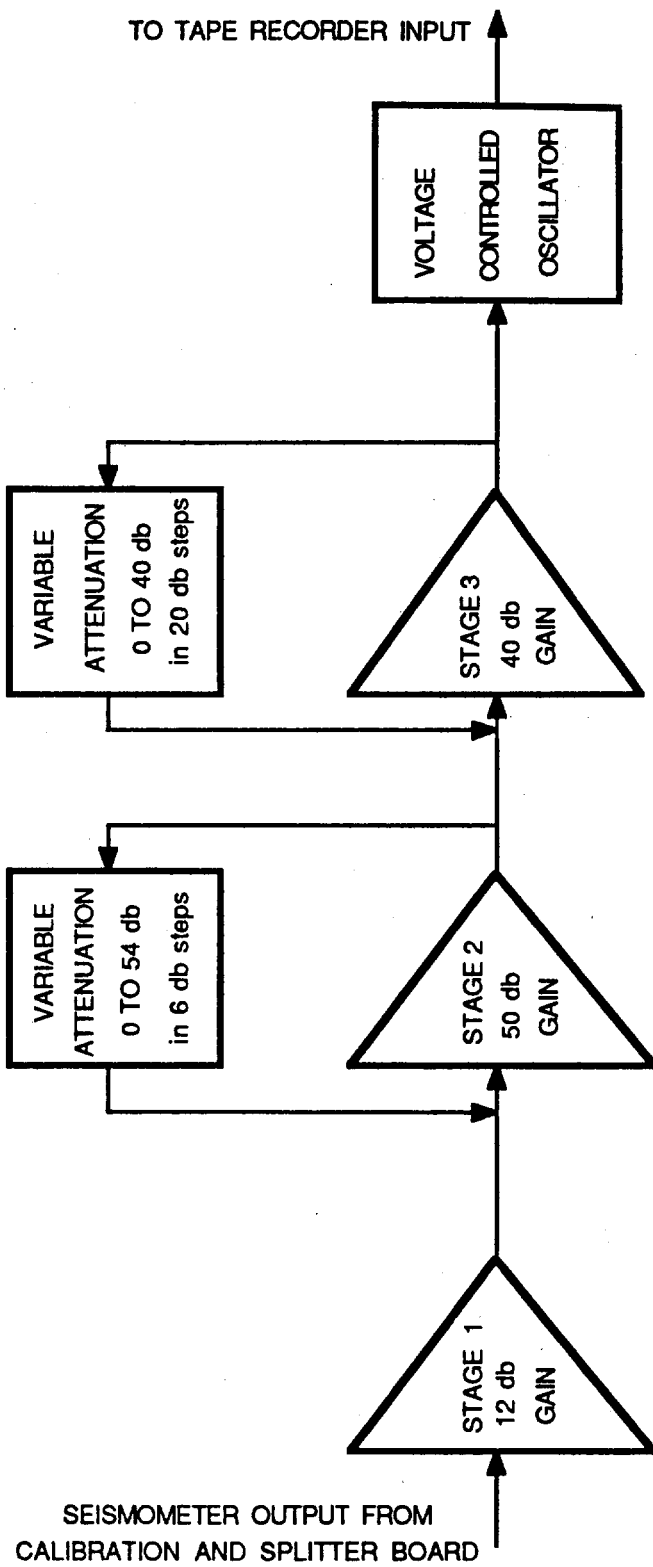

Figure 1.6. Block diagram of the amplifier/VCO.

frequency deviation is ± 125 Hz. The center frequencies are referred to as carriers of a channel. Calibration of the VCO is not performed independently, but is part of the system calibration discussed in the diagnostics and calibration section.

The time standard for each unit is provided by a Vectron LaboratoriesTM (Table 1.4) model 252-1631 crystal oscillator. The internal quartz crystal oscillates at 1 MHz and is frequency adjustable within the range ± 5 Hz (5 parts per million). The unit is temperature compensated with an accuracy of $\pm 1 \times 10^{-7}$ (1 part per 10 million) for the temperature range 0°C to 50°C . This stability corresponds to less than 10 milliseconds error per day. After the instruments are retrieved from the field, drift rates for each instrument are measured against a more stable master clock, which is periodically synchronized with the world wide standard, WWVB. Following the manufacturer's practice, we assume a linear drift rate between the time the clock is set and the time it's drift is measured and correct the data during the digitizing stage. When an instrument drift of more than 50 milliseconds is recorded during any given deployment (approximately 36 hours), the clock unit is adjusted.

IRIG E, the serial time code output of the clock unit, is frequency modulated on a 3500 Hz carrier with a maximum deviation of ± 50 Hz. The three data carriers, the clock carrier, and a tape-speed compensation reference carrier of 4687.5 Hz are summed and recorded in analog form with a Phi-DeckTM cassette magnetic tape deck. The reference carrier is derived from a MonitorTM (Table 1.4) quartz crystal oscillator which is set at at 2.400 MHz $\pm 0.006\%$ (6 parts per 100 thousand) between the temperatures 0°C and 30°C . Thus, the accuracy of the reference frequency is ± 144 Hz over this temperature range.

DIGITIZING UNIT

USGS-designed digitizing systems retrieve and digitize the recorded data (Figure 1.7). These systems are controlled by Digital Equipment Corporation (DEC)TM PDP-11/23 computers with RT11 operating systems. They contain a Triple I Phi-DeckTM cassette tape drive with tape-speed compensation, TRI-COMTM discriminators, a DatumTM time code translator, a DRV11 parallel line interface, and a DEC ADV11-C 12 bit analog-to-digital converter (ADC). For each component Table 1.4 lists the manufacturers and the specifications. The analog signal read by the tape deck goes to a bank of 5-pole TRI-COMTM 502 FM discriminators. Each discriminator, except the reference discriminator, bandpass filters the carrier signal about a separate center frequency and converts the FM signal back to voltages. As in the recorders, center frequencies are 680 Hz, 1020 Hz, and 1360 Hz for data channels 1, 2, and 3, respectively, and 3500 Hz for the time-code channel. The width of the bandpass filter for each data channel is 250 Hz which equals the maximum frequency deviation in the recorders. To allow for better resolution of the time signal, a band width of 500 Hz is used. The tape-speed-compensation discriminator demultiplexes the reference frequency of approximately 4687.5 Hz

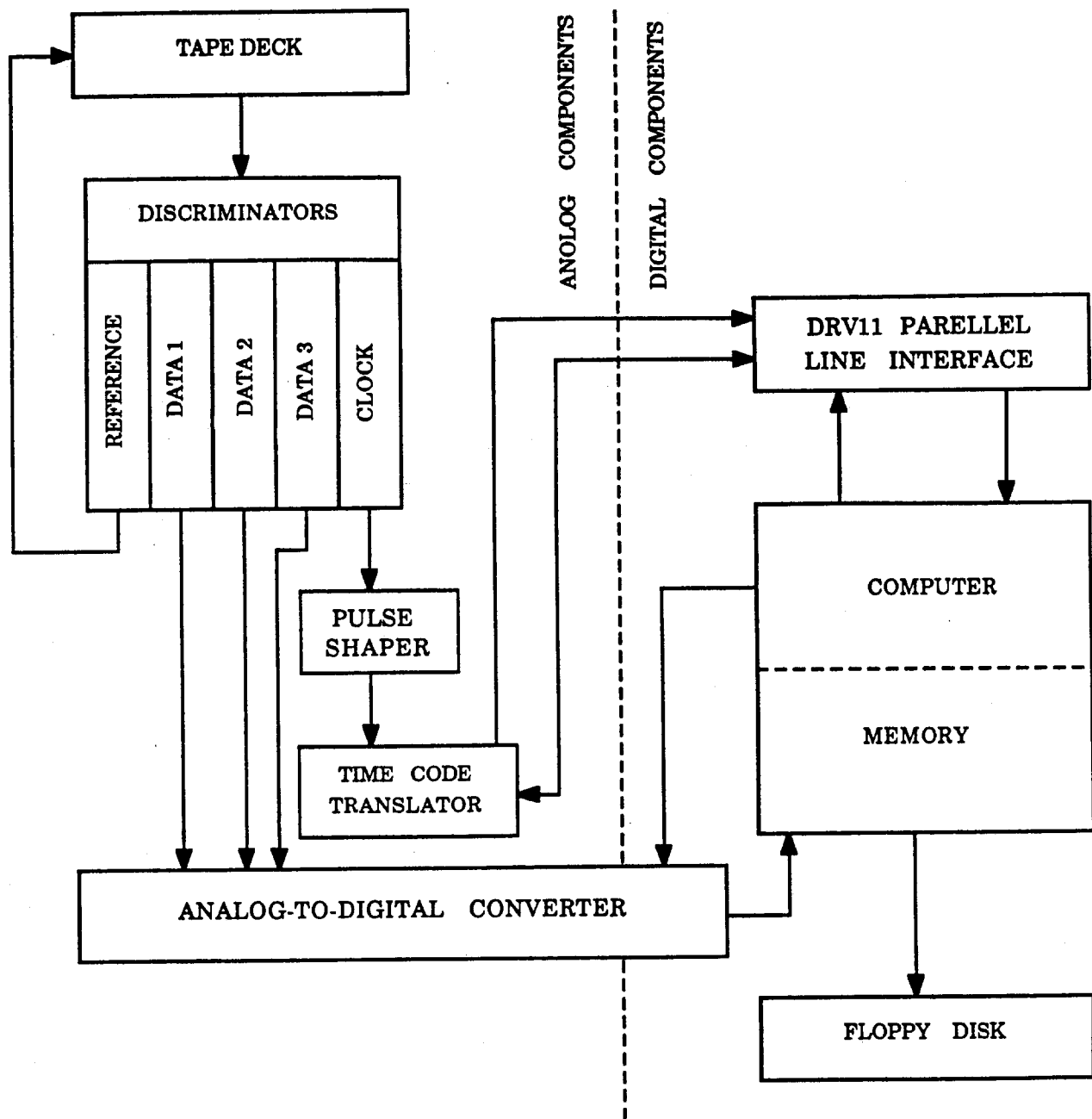

Figure 1.7. Diagram of the digitizing unit.

and sends it to the tape-speed-compensation circuit and to each of the data discriminators. The reference frequency sent to the tape-speed-compensation circuit is compared to a frequency of 4687.5 Hz generated locally by another Monitor™ (Table 1.4) quartz-crystal oscillator. To match the reference frequency from the tape to this local standard, the tape speed compensation circuit continuously adjusts the speed of the tape deck ("capstan compensation"). Thus, the tape is played back at nearly the same speed it was recorded, preventing accidental shifting of the data-carrier frequencies. The tape-speed-compensation signal sent to the data discriminators is combined with the data signal through a process called "subtractive compensation". Subtractive compensation removes most of the system noise produced by rapid tape-speed fluctuations.

After the time code is converted back to a voltage, it is sent to a Datum™ time-code translator, where it is decoded and a 200 pulse per second signal is generated. The decoded time signal is transmitted continuously to the computer using the bit map shown in Figure 1.8. In order to decode the time, the translator must read at least 10 seconds of the code. Once the translator decodes the time, it compares and updates the time every 0.1 s. If the time code deteriorates, the translator must complete the next readable ten-second time-code frame before it again transmits synchronized time to the computer. Thus, for a single read-error, there may be up to 20 seconds between synchronized time signals to the computer. During this time, an error flag is set (ERR, Figure 1.8). In addition to signal-level errors, the time code translator compares successive 10 sec frames to determine whether the time code is decoding correctly. If the translator detects an error, a non-synchronization flag is set and an error flag (ERR, Figure 1.8) is set.

For input deviations of - 125 Hz and + 125 Hz about the center frequency, the data discriminators, channels 1, 2, and 3, produce voltages between -5 and +5 volts, respectively. These voltages are input to a DEC ADV11-C ADC in bipolar mode (via single-ended inputs), where they are converted to digital data in offset-binary format. In octal, the outputs from the ADC are: 000000 at -5.0 volts, 004000 at 0.0 volts, and 007777 at +4.9975 volts. In base 10, input voltages of -5.0, 0.0, and +4.9975 are output as 0, 2048, and 4095 digital counts, respectively, or about 2.44 mv/count. Digitizing is initiated under program control by setting the ADC start bit in the control/status register. The time code translator sends the 200 pulse per second signal to the computer through the DRV11 parallel line interface. This signal is input to REQB which is polled by the computer. Each time a pulse is generated, the computer digitizes a sample on each data channel. The digitized data are stored on 8-inch floppy disks with a maximum storage capacity of 5 Mbytes. Thus it is possible for each disk to store 61 separate seismic traces assuming 20 sec of data per trace and a sample rate of 200 samples per second.

SYSTEM RESPONSE

Because tape-speed fluctuations during playback limit the dynamic range of each channel to 25 db, subtractive compensation is used to enhance the signal

15	14	13	12	11	10	09	08	07	06	05	04	03	02	01	00	BIT No.			
RECORDER SERIAL NUMBER																			
																	HUNDREDS		
8 4 2 1				8 4 2 1				8 4 2 1				8 4 2 1							
																HOURS			
2 1				4 2 1				8 4 2 1				4 2 1				8 4 2 1			
DAYS																			
8 4 2 1				8 4 2 1				8 4 2 1				8 4 2 1				8 4 2 1			
E R R				8 4 2 1				8 4 2 1				8 4 2 1				8 4 2 1			
MILLISECONDS																			
HOURS																			
DAYS																			
MILLISECONDS																			
8 4 2 1				8 4 2 1				8 4 2 1				8 4 2 1				8 4 2 1			
E R R				8 4 2 1				8 4 2 1				8 4 2 1				8 4 2 1			
MILLISECONDS																			
HOURS																			
DAYS																			
MILLISECONDS																			
15	14	13	12	11	10	09	08	07	06	05	04	03	02	01	00	BIT No.			

Figure 1.8. Word format for parallel transmission of time data.

LOS - Loss of input code

ERR - Code frame error

and widen the dynamic range as described above. With subtractive compensation, each channel has a dynamic range of about 48 db. Channel attenuations are usually set 18 db apart so that the dynamic ranges overlap. For example, a typical set of attenuations is 12 db, 30 db, and 48 db for channels 2, 1, and 3, respectively. Therefore, the gain of each channel is 90 db, 72 db, and 54 db, respectively, and individual channel dynamic ranges are 42-90 db, 24-72 db, and 6-54 db, respectively. In this example, the effective dynamic range of the system is 84 db and at any level within this range the signal-to-noise ratio is acceptable.

The recording system velocity response is roughly flat between 2 and 30 Hz. At low frequencies the response is determined by the geophone, which has a corner frequency of 2 Hz. The response rolls off at 12 db/octave between 2 Hz and 0.1 Hz and at 24 db/octave below 0.1 Hz (J. Van Shaack, oral comm., 1987). Characteristics of the amplifier and VCO determine the low-pass frequency response. This response is similar to a 2-pole Butterworth filter with a corner frequency of 30 Hz and a rolloff of 12 db/octave (J. Van Shaack, oral comm., 1987). Corner frequency is defined as the point where the response is 3 db below the maximum.

If the frequency response of each component is approximated by a theoretical transfer function, the frequency response of the complete system (recorder and digitizer) may be described by the product of the individual component transfer functions (Healy and O'Neil, 1977; Stewart and O'Neil, 1980; Dratler, 1980). With this method, the program RESPONSE (Stewart and O'Neil, 1980) computes amplitude and phase spectra from parameters that describe the frequency response of each component. The seismometer and L-pad, J402 amplifier and VCO, and Tri-Comm discriminators used in this system are among several types of components analyzed by Dratler (1980) and Stewart and O'Neil (1980). Parameters for the components are given by Stewart and O'Neil (1980) and are reproduced here in Table 1.1. Although the ADC was not analyzed specifically, Stewart and O'Neil state that ADC's generally have no relevant poles and, therefore, that only the conversion factor (2.44 mV/count) need be included. The amplitude response factor of the ADC is listed in Table 1.2. Figure 1.9 (from Dawson and Stauber, 1986) shows the amplitude response curves derived from analysis of the system with the RESPONSE program (modified by P. Dawson). Because the amplitude response, $A(t)$, is relatively flat for the frequencies between 2 Hz and 30 Hz, it may be approximated by a simple equation combining the products of ground velocity, $A_g(t)$, and the amplitude factors of the major components:

$$A(t) = [R_{GLE} R_{SA} R_{VCO} D_{DSC} D_{ADC}] A_g(t)$$

where

- R_{GLE} is the effective generator constant of the seismometer and L-pad (V/cm/s).
- R_{SA} is the system amplification (gain, V/V).
- R_{VCO} is the deviation sensitivity of the VCO (Hz/V).
- D_{DSC} is the deviation sensitivity of the discriminator (V/Hz).
- D_{ADC} is the sensitivity of the ADC board (counts/V).

TABLE 1.1

COMPONENT	f_0 (Hz)	β	TOTAL NO. OF POLES: (L TYPE; m)	LOW-FREQ. FALL-OFF (LN; L)	C-FACTOR POW: α_j α_k	SPECTRAL ELEMENT	AMPLITUDE OR SENSITIVITY FACTOR
1. Seismometer with L-pad	1.0	0.8	2	3	1 1	$i\omega^3 / (\omega-d_1)(\omega-d_2)$	$G_{LE} = 1.0 \text{ V}/(\text{cm}/\text{sec})$
2. J702 Amplifier/VCO Laboratory Calibration	0.095	1.0	2	2	1 1	$\omega^2 / (\omega-d_1)(\omega-d_2)$	Amplifier gain: see Table 3 or 4. VCO: $\pm 125 \text{ Hz}/\pm 3.375 \text{ V}$ = 37.04 Hz/V
	44.0	1.0	2	0	ω_0 ω_0	$-1 / (\omega-d_1)(\omega-d_2)$	
Dretler (1980)	0.085	*	1	1	1	$\omega / (\omega-d_1)$	Amplifier gain: see Table 3 or 4. VCO: $\pm 125 \text{ Hz}/\pm 3.375 \text{ V}$ = 37.04 Hz/V
	0.096	*	1	1	1	$\omega / (\omega-d_1)$	
	48.4	*	1	0	ω_0 ω	$-i / (\omega-d_1)$	
	49.8	*	1	0	ω_0 ω	$-i / (\omega-d_1)$	
3. Discriminator Tri-Com Dwyler (1980)	45.1	*	1	0	ω_0 ω	$-i / (\omega-d_1)$	$\pm 2.0 \text{ V}/\pm 125 \text{ Hz}$ = 0.0160 V/Hz
	46.7	0.987	2	0	ω_0 ω_0	$-1 / (\omega-d_1)(\omega-d_2)$	
	52.7	0.546	2	0	ω_0 ω_0	$-1 / (\omega-d_1)(\omega-d_2)$	

TABLE 1.2

<u>component</u>	<u>value</u>
R _{GLE}	1 V/cm/sec
R _{SA}	dimensionless gain variable V/V
R _{VCO}	25 Hz/V
D _{DSC}	0.04 V/Hz
D _{ADC}	409.6 counts/V

Table 1.3

<u>attenuation</u>	<u>gain (R_{SA})</u>
12	31,623
30	3981
48	501
68	50.1
88	5.01

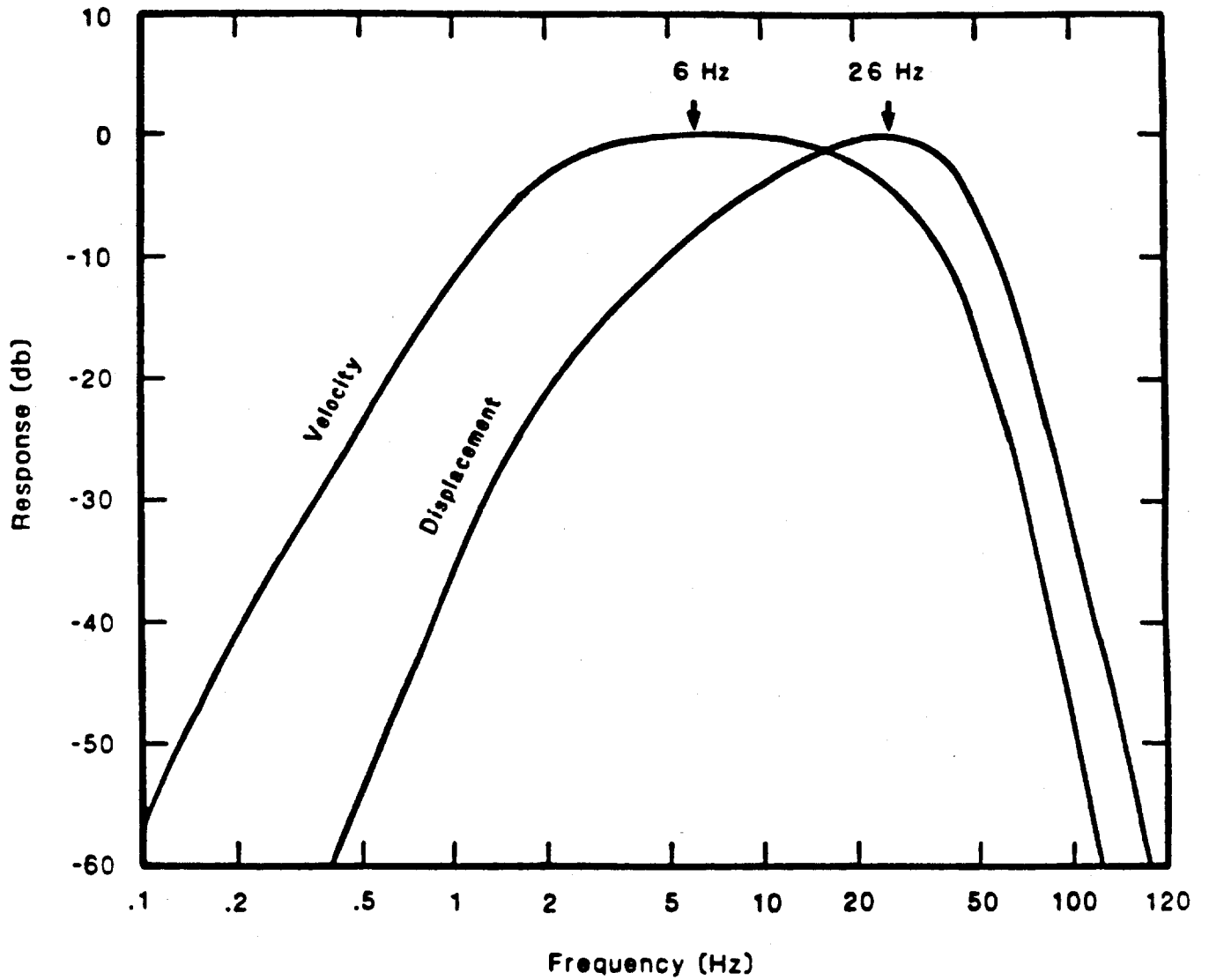

Figure 1.9. Theoretical Transfer-function curves for the USGS short-period seismic refraction system (both recorder and digitizer). Solid lines are the displacement and velocity normalized amplitude. (From Dawson and Stauber, 1986)

Values for individual components are listed in Table 1.2. The system gain (R_{SA}) varies for each channel of each instrument and is determined by the equation:

$$R_{SA} = 10^{\left(\frac{102 - a}{20}\right)}$$

where "a" is the attenuation setting. Some commonly used gains are listed in Table 3.

Thus approximate ground motion is given by:

$$A_g(t) = \frac{A(t)}{R_{GLE} R_{SA} R_{VCO} D_{DSC} D_{ADC}} = \frac{A(t)}{(409.6) R_{SA}}$$

Dawson and Stauber (1986) use this method to calculate approximate ground motion from recorded seismograms.

DIAGNOSTICS AND CALIBRATION

After a stabilization period lasting 8 minutes 38 seconds, the recording unit performs a series of diagnostic tests and calibrations lasting 1 minute, 15 seconds. These signals are recorded on the cassette tape prior to the seismic recording (Figure 1.10). These records are used to help diagnose instrument failures. Prior to subsequent deployment, malfunctioning instruments are repaired. The diagnostic and calibration sequence consists of a seismometer pulse, an amplifier step, and 10-Hz sine-wave calibration signals at 1, 10, 100, and 1000 microvolts RMS. The seismometer pulse indicates the frequency response of the geophone and reveals malfunctions of the seismometer. Amplifier frequency response and malfunctions may be diagnosed using the amplifier step portion of the diagnostics.

Finally, during the 10-Hz calibration test, four separate voltage levels are recorded. These voltage levels are digitized along with the seismic data and from them gain levels can be verified and refined. In designing the refraction data-acquisition system, it was recognized that many parts of the system affect the final recorded signal. This complexity makes calibrating the final signal by calibrating individual parts difficult and unreliable. Hence, the four sine-waves are used to provide a complete system calibration scheme. The actual digitized calibration signal is not saved only the mean peak-to-peak amplitude (in digital counts) is saved for each separate RMS voltage level. In order to calculate the actual gain, the system response equation is used, the unknown being R_{SA} . Thus,

$$R_{SA} = \frac{A(t)}{[R_{VCO} D_{DSC} D_{ADC}] A_{CAL}(t) 2\sqrt{2}}$$

where R_{VCO} , D_{DSC} , and D_{ADC} are defined as given in the system response

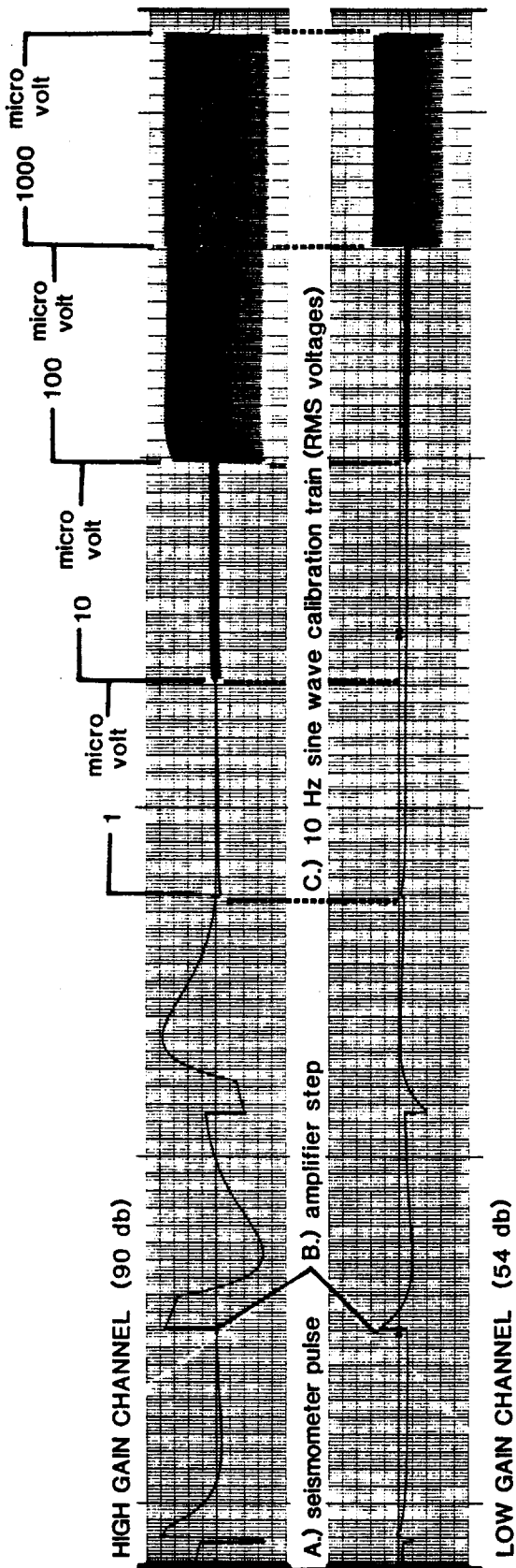

Figure 1.10. Diagnostics and calibration sequence performed by the recording unit each time the unit is activated. Displayed are two channels with a gain separation of 36 db. The top channel has a gain of 90 db and the bottom channel has a gain of 54 db. Note, the signal output of the 1000 microvolt calibration, the amplifier step, and the seismometer pulse on the high gain channel are all clipped. These signals are limited by the dynamic range of the amplifier. However, the 1000 microvolt signal is within the dynamic range of the low gain channel. RMS values are given for the calibration voltages.

section. $A_{CAL}(t)$ is the RMS amplitude of the calibration signal in volts, and 2.2 is a multiplier used to convert RMS amplitude to peak-to-peak amplitude for a sine wave. $A(t)$ is the mean peak-to-peak amplitude of the digitized sine wave.

TIME CODE

Universal Coordinated Time (UTC) is recorded on the cassettes as an IRIG-E signal, multiplexed with other signals as described above. IRIG-E is a "binary-coded-decimal" (BCD) serial time signal originally designed for NASA telemetry. It encodes time as a series of signal-level shifts which begin at an exact UTC time and persist for one of three periods: "wide", "medium", and "narrow". In IRIG-E, these pulses occur every 0.1s and are 80, 50, and 20 ms long, respectively. Wide pulses are used to mark reference points in the time code. Each 1-s point is preceded by a single wide pulse, and each 10-s point is bracketed by two wide pulses (Figure 1.11A). Thus, two types of time frames are defined: 1) a 1-s frame and 2) a 10-s frame.

Within each 1-s frame (10 pulses in IRIG-E), up to two decimal digits are encoded using medium pulses for ones and narrow pulses for zeros. A narrow divider pulse separates the first decimal digit, encoded in the first four successive pulses, from the second decimal digit, encoded in the remaining successive pulses. The BCD code used is simply a 4-bit unsigned binary number in the range $0000_2=0_{10}$ to $1001_2=9_{10}$. The bits are in reverse order, low-order bit first. For example, a code of 1010 represents $0101_2=5_{10}$. The 4-pulse groups and their significance for IRIG-E are shown in Figures 1.11 B-G. Appendix A describes a method of reading IRIG-E in base 10 from plots.

Because wide pulses are used to mark reference points and each 1-s frame contains a divider pulse, the entire ten pulses per second is never used for coding. Each 1-s frame uses at most 8 pulses for encoding information and in the first second frame after a ten second point, only 7 pulses are available for encoding. The latter is possible because the seconds digit in the tens position never exceeds $101_2=5_{10}$ (50 s; Figure 1.10B).

The time encoded with these digits is the UTC time of the starting point for that 10-s frame. It is given as Julian days, minutes, and seconds. A fully encoded UTC time is recorded in each 10-s frame, along with the serial number of the recorder. The time-code translator synchronizes to this code and then updates its output continuously to reflect the (anticipated) UTC time at that point in the coded signal. Disagreement between this anticipated time and subsequently translated BCD codes cause a "synchronization" error as described above.

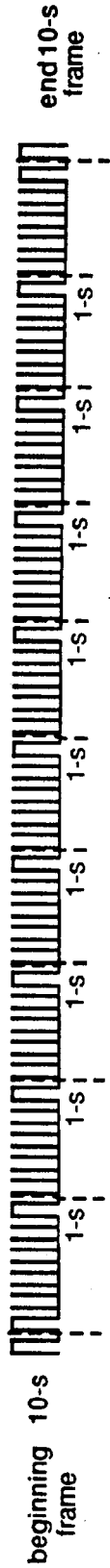

A.) Ten second time code frame.

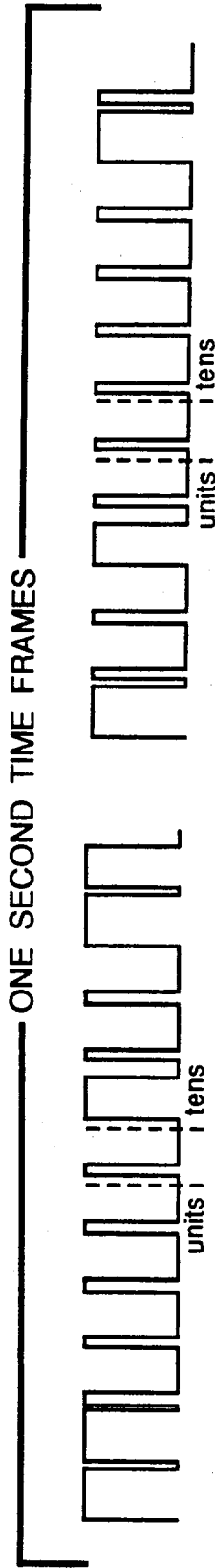

B.) First 1-s time frame represents seconds.

E.) Fourth 1-s time frame represents units and tens of the 3-digit Julian date.

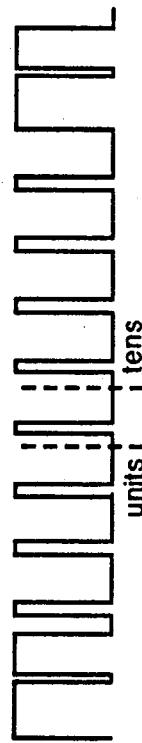

C.) Second 1-s time frame represents minutes.

F.) Fifth 1-s time frame represents hundreds of 3-digit Julian date and units of the 3-digit recorder serial number.

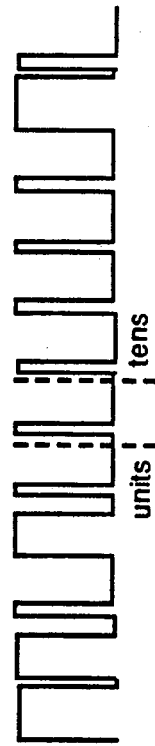

D.) Third 1-s time frame represents hours.

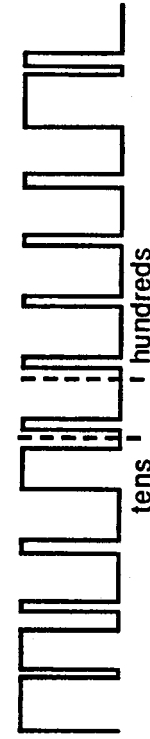

G.) Sixth 1-s time frame represents tens and hundreds of the 3-digit recorder serial number

Figure 1.11. IRIG-E time code.

Table 1.4

MANUFACTURERS OF THE MAJOR COMPONENTS

Mark Products, Inc.
10507 Kinghurst Dr.
Houston, Texas 77099
(713)498-0600

specification: L-4A 1.0 Hz and 2.0 Hz land or borehole geophone

Vectron Laboratories, Inc.
166 Glover Ave.
Norwalk, Connecticut 06850
(203)853-4433

specification: CO-251 through CO-256; TCXO

Monitor Products Company, Inc.
P.O. Box 1966
Oceanside, California 92054
(619)433-4510

specification: quartz crystal oscillator

Triple I, Inc.
4605 North Stiles
P.O. Box 18209
Oklahoma City, Oklahoma 73118
(405)521-9000

specification: Phi-deck cassette tape deck

Tri-Com, Inc.
7304 Grove Road
Fredrick, Maryland 21701
(301)694-6666

specification: Model 502 FM discriminator

Datum, Inc.
1363 S. State College Boulevard
Anaheim, California 92806
(714)533-6333

specification: Model 9210 Time code Translator Part number 9210-716

Table 1.4 (continued)

MANUFACTURERS OF THE MAJOR COMPONENTS

Digital Equipment Corporation
Maynardver Ave.
Maynard, Massachusetts 06850
(617)897-5111

specification for ADC and DRV11 parellel line interface:
PDP-11 Microcomputer Interfaces Handbook

Chapter 2: Seismic Cassette Recorder Users Guide

INTRODUCTION

The seismic cassette recorders (SCR) are used to record seismic data in analog form. In order to program these instruments, two other instruments -- a master clock (time reference) and a hand held tester (HHT) -- are used to synchronize the SCR internal clock and set the recording parameters. The same type of clock used in the recording units is used in the HHT. Because these clocks are not accurate enough, a master clock is used as the time reference. The master clocks drift less than 1 ms per week and are periodically checked against a universal time standard relayed by satellites.

Programming a SCR requires 1) setting channel attenuations, 2) synchronizing the SCR's internal clock with a time standard such as a master clock, and 3) programming the internal logic (hereafter called the memory) to turn on the SCR at preset times. The hand held tester (HHT) performs two of these functions during programming -- adjusting the SCR's internal clock and loading the SCR's memory. To synchronize the SCR's clock with the time standard, first, the HHT's clock is synchronized with a master clock, then the SCR's clock is synchronized with the HHT's clock. While this procedure introduces a drift from the HHT's clock, the drift is small because the programming period is short. Before loading the SCR's memory, the HHT's memory must first be programmed. The turn on times and recording durations are then transmitted via a 48-wire cable to the SCR's memory. During a normal programming session, the HHT is programmed first (memory and clock), then it is used to successively program each of the SCRs. After the last SCR is programmed, the HHT is again compared to the master clock to determine the drift of the HHT clock during programming. As discussed in the "recording unit" section, after the SCRs are retrieved, their drift times are recorded on data sheets. The procedure used to measure the drift is similar to that used to synchronize the SCR's clocks. Drift times for both the HHT and the SCRs are entered into the computer and a drift time correction is made to the data during data processing.

In order to communicate programming procedures to readers unfamiliar with these devices, various terms will first be defined and discussed, followed by a description of SCR and HHT controls. Programming procedures will be given last.

DEFINITIONS AND GENERAL INFORMATION

Recording parameters

"Shot time" is the time an explosion is scheduled to be detonated. The SCR's are programmed to turn on ten minutes prior to shot time to allow the SCR to stabilize, perform and record diagnostic tests, and record calibration signals (Figure 2.1). The time actually programmed is called the instrument "turn on time". The instrument turn on time and a numerical code , N,

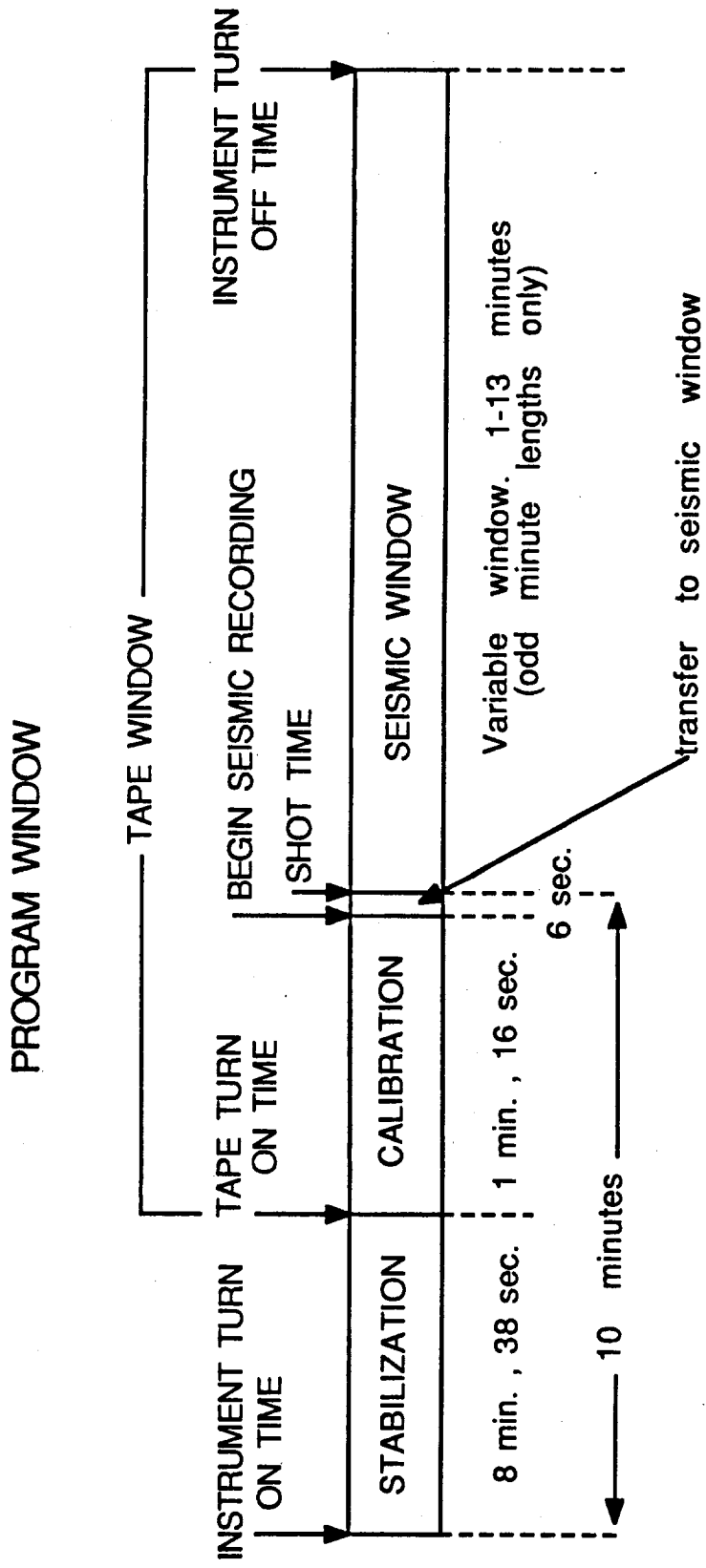

Figure 2.1. Schematic diagram of the recording sequence.

Note: When recording seismic refraction data, the instruments are normally turned on ten minutes prior to shot time.

indicating the recording duration will be referred to as "recording parameters" of a "program window". The function $2N-1$ determines the number of minutes the SCR will record seismic data. This period is called the "seismic window" (Table 2.1). The maximum recording duration code is 7, so the maximum seismic window for one program window is 13 minutes. To extend the seismic window beyond 13 minutes, two overlapping program windows are entered into the memory. For each non-overlapping window, an additional 1 minute and 16 seconds is used to record the diagnostic tests and calibration wave train. Additionally, the first 6 seconds of the seismic window are used for transfer to seismic sensing. Therefore, the "tape window" (the length of time the tape runs) is $2N$ minutes plus 22 seconds and the instrument turn on time is 10 minutes prior to shot time.

Recording a seismic window longer than 13 minutes requires two (or more) program windows. The instrument turn on time of the second program window should overlap the instrument turn off time of the first program window. For the second program window, the instrument will not run through a stabilization period and no diagnostic tests or calibration signals are performed or recorded (Figure 2.2) so the instrument turn on time equals the "shot time" of figure 2.1. Normally, to extend the seismic window beyond 13 minutes, the first program window contains a 13 minute seismic window ($N=7$), and the second program window contains an instrument turn on time 22 minutes after the instrument turn on time in the first program window. In other words, the instrument turn on time of the second program window is 1 minute prior to the instrument turn off time of the first program window (10 minute stabilization, calibration, and transfer time plus 13 minute seismic window = 23 minute program window). In this case, the seismic window is extended by $2N-2$ minutes, where N is the recording duration code entered in the second program window and the instrument turn on time of the second program window is also the shot time (Figure 2.2). For example, to have a seismic window 21 minutes long with seismic recording to start at 0600, the recording parameters in the first program window should be: $N=7$, and instrument turn on time = 0550. The recording parameters in the second program window should be: $N=5$, and instrument turn on time = 0612. The seismic window may be extended further by adding a third program window which overlaps the second. Therefore, the recording duration is limited only by the amount of tape available (30 minutes).

There are ten program windows available in the SCR memory and all ten must be programmed with recording parameters. Duplication of the recording parameters is not only permitted, it is recommended because it reduces the probability of an SCR failure due to a memory malfunction. For example, to program two turn on times, the programmer typically enters recording parameters for the first turn on time in the first five program windows and recording parameters for the second turn on time in the last five program windows. Examples of program windows are given in Table 2.2.

Table 2.1

SESMIC WINDOW LENGTHS

<u>N</u>	<u>SEISMIC WINDOW (min)</u>
1	1
2	3
3	5
4	7
5	9
6	11
7	13

Table 2.2

PROGRAM WINDOW EXAMPLES

<u>PROGRAM WINDOW</u>	<u>DESCRIPTION</u>
7850620	13 minute seismic window beginning at *85 06 30 GMT (*85 = Julian day 185, or 285)
5420450	9 minute seismic window beginning at *42 05 00 GMT (*42 = Julian day 142, 242, or 342)
7221850 7221912 3221924	29 minute seismic window beginning at *22 19 00 GMT (*22 = Julian day 122, 222, or 322)

PROGRAM WINDOW 1

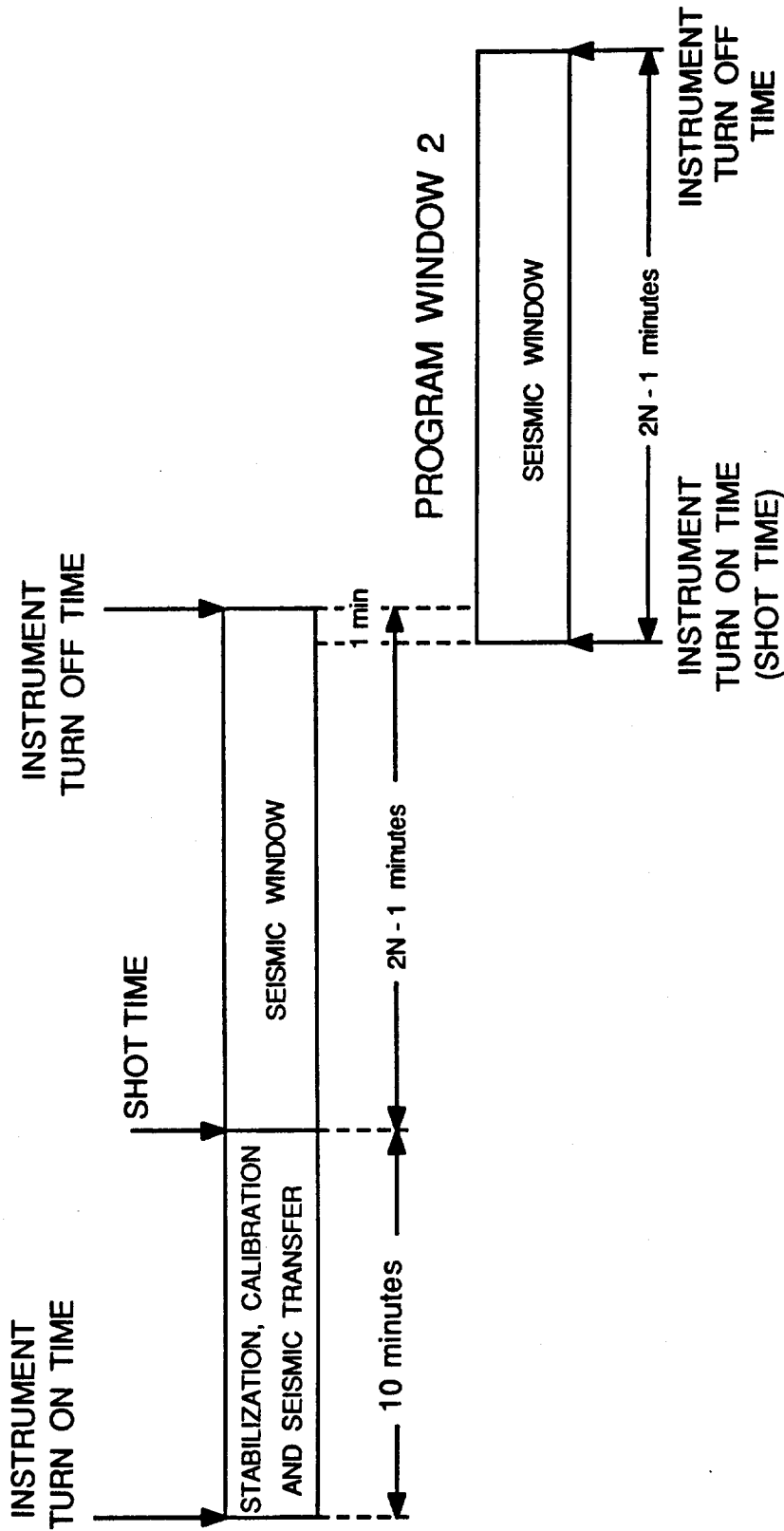

Figure 2.2. Schematic diagram of the extended recording sequence.
 Note: Two program windows are used.

Batteries

The batteries for both the SCRs and HHTs can be recharged without removing them from the instrument. A specially designed charging unit is built to charge 20 instruments and 1 HHT simultaneously. The charging unit consists of a power supply, a bank of 5-ohm resistors, and 21 2-wire cables with connectors. Two separate boxes house the resistor banks with ten test points each (the HHT connector has no test point). The power supply is connected to the resistor banks through detachable pairs of wires. The input to the power supply is 110 V AC current and the output is a DC current at one of two voltage levels -- 14.9 V and 13.6 V. The charging unit's low voltage level is used to maintain the batteries during nonuse periods and the high voltage level is used to quickly recharge the batteries after the SCR's have been used to record data. The batteries are fully charged when the charging unit's output is 14.9 V and the batteries are drawing a current of approximately 100 mA.

The condition of the batteries can be monitored at the test points on the resistor banks (Figure 2.3). To determine how much current the batteries are drawing, measure the voltage drop across the resistor with a volt meter. The current being drawn by the batteries is the voltage drop divided by the resistance. Therefore, the batteries are fully charged when the voltage drop is approximately 0.5 V.

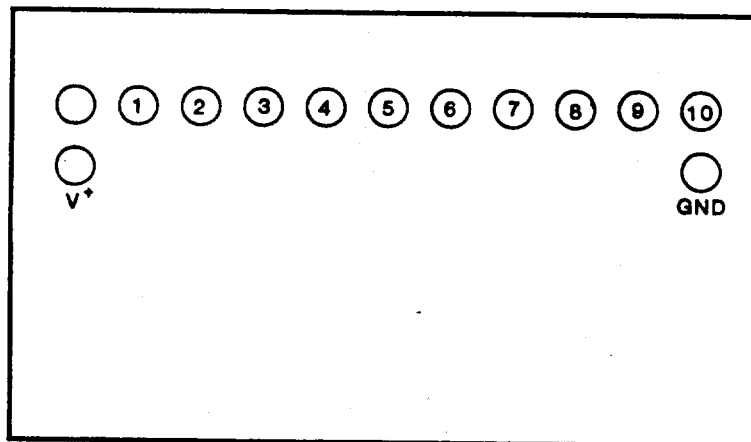

Figure 2.3. Schematic diagram of the resistor bank. 1 - 10 are the test points to measure the current being drawn by the SCR batteries.

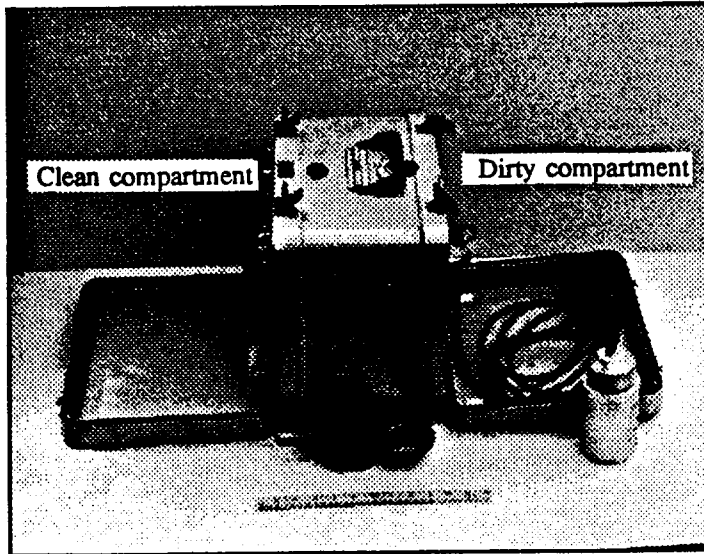

Figure 2.4 Seismic Cassette Recorder (SCR).

SCR

An SCR has two outer compartments that can be accessed by opening latched lids (Figure 2.4). The seismometer, a 48-pin connector, and the battery recharging connector are housed in the so called "dirty" compartment. This compartment is often contaminated by dirt from the seismometer. When the seismometer is deployed or when the batteries are being recharged, this compartment remains unlatched. The latches should not be engaged when wires are exiting the lid, as this may damage them. The other outer compartment, called the "clean" compartment, houses the SCR user interface and data cassette recorder.

Field Notes

Field notes are recorded on two data sheets -- the "recorder field data sheet" (alias "blue sheet") and the "deployment timing check list" (also called "white sheet"). The blue sheets are used to record attenuation settings and symptoms of instrument malfunctions. They are also used to associate a field location number with an SCR instrument serial number and a computer location number. The white sheets are used to record all timing information. Figure 2.5 is a blue sheet and figure 2.6 is a white sheet.

RECORDER FIELD DATA SHEET

Experiment: _____ Shot No.: _____
 Deployment No.: _____ Team No.: _____ Shot Date: _____
 Observers: _____ Julian Day: _____
 Attenuations: ch 1 _____ ch 2 _____ ch 3 _____

	COMPUTER LOCATION NUMBER	UNIT NUMBER	FIELD LOCATION NUMBER	TAPE GRADE	<u>NOTES</u> Include any attenuations which are different than those listed above
1					
2					
3					
4					
5					
6					
7					
8					
9					
10					
11					
12					
13					
14					
15					
16					
17					
18					
19					
20					

Figure 2.5. Recorder field data sheet (blue sheet).

SCR PROJECT PROFILE														
Deployment No.: _____					HHT SET TIME _____					DRIFT _____				
Shot Date: _____ Julian Day: _____					HHT CHECK TIME _____					} _____				
Team No.: _____					HHT RESET TIME _____					} _____				
Observers: _____					HHT RECHECK TIME _____					} _____				
DEPLOYMENT & TIMING CHECK LIST														
PRE-DEPLOYMENT						POST-DEPLOYMENT								
UNIT	CLOCK SET			M E M	A T T	C A P E	T A P E	CLOCK CHECK			D R I F T (mSEC)	R U N	W V B	I N S T R U M E N T P E R F O R M A N C E
	DAY	HR	MIN					DAY	HR	MIN				
1														
2														
3														
4														
5														
6														
7														
8														
9														
10														
11														
12														
13														
14														
15														
16														
17														
18														
19														
20														

Figure 2.6. Deployment timing check list (white sheet).

Past disasters and how to avoid them

Over the years we have encountered various problems in SCR use. Some of these can be avoided and are discussed here.

In the SCR's tape deck, the tape from the cassette runs between a small light and a photo sensor. The photo sensor turns off the tape recorder when it senses the light. Therefore, the cassette tapes must be wound past the transparent leader before they are inserted into the tape deck port. Normally we use only "no hole" cassette tapes, but "holed" tapes can be used if the tape is wound past the hole (which is an end-of-tape marker). Cassette tapes should be checked to determine whether there is a loading marker hole.

The most common reason an SCR will not record data is that the cassette tape is not seated properly in the tape deck port. This is a persistent problem because the tapes are often unseated during transport to the field site. To eliminate this problem, observers remove the tape at the field location site, manually wind the tape until it is taught, and then place the tape back in the tape deck port. Then the tape is tapped gently to ensure proper seating.

Jarring during transport may cause loose objects stored in the outer compartments to fly around the compartment. Free flying objects in the clean compartment sometimes hit the RUN/HOLD switch with sufficient momentum to turn off the internal clock. For this reason nothing should be placed inside the clean compartment (i.e. empty cassette tape cases).

Lastly, connecting the SCRs to the battery recharger and failing to turn on the power supply can cause the batteries to drain if any of the SCRs has a current leak (short circuit). This problem is avoided by disconnecting the charging cables when they are not in use. Short circuits can be detected by checking the voltage drops across the resistors.

DESCRIPTION OF HHT AND SCR CONTROLS

HHT

In order to simplify descriptions of the HHT, the front panel has been subdivided schematically into five subregions — a display region, an SCR remote control region, a memory region, a HHT clock control region, and a general functions region (Figure 2.7). In the display region, the left two liquid crystal displays show either the time of the HHT clock or the recording parameters of a single program window. The function displayed is determined by the display toggle switch ("25" on Figure 2.7). A memory entry is displayed when this display switch is in the "M" position and the clock's time is displayed when the display switch is in the "C" position. When the time is displayed, the Julian day appears in the left display and the hours, minutes, and seconds appear in the center display separated by colons. Each time-division is displayed in normal base 10 format (units, tens, and

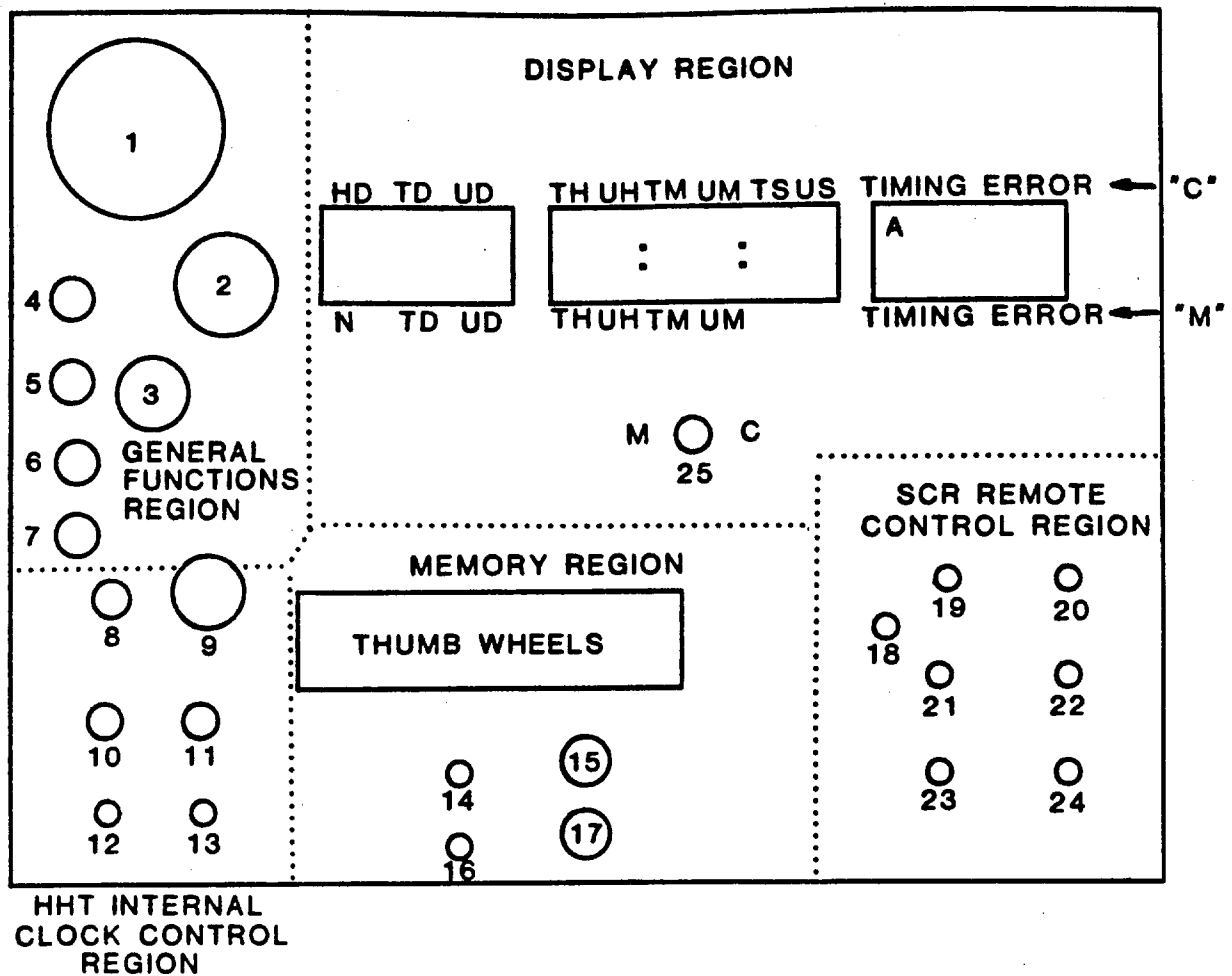

Figure 2.7. HHT front panel.

GENERAL FUNCTIONS REGION

1. I/O connector
2. Battery recharger connector
3. Monitor switch
4. Test point A
5. Test point B
6. Test point for time code
7. Test point ground

HHT INTERNAL CLOCK CONTROL REGION

8. Set button
9. Time division switch
(HD, TD, UD, TH, UH, TM, UM, TS)
10. RUN/HOLD switch
11. Reset button
12. ADV/RET switch (HHT clock)
13. Rate switch

MEMORY REGION

14. Select switch (HHT/SCR)
15. Auto load button
16. Enter button
17. Reset button

SCR REMOTE CONTROL REGION

18. External calibration switch (not used)
19. ADV/RET switch
20. Rate switch
21. Tape recorder play switch
22. Tape recorder direction switch
23. Tape recorder power switch
24. VCO power switch

DISPLAY REGION

- HD - hundreds of day (Julian)
 TD - tens of day (Julian)
 UD - units of day (Julian)
 TH - tens of hours
 UH - units of hours
 TM - tens of minutes
 UM - units of minutes
 TS - tens of seconds
 US - units of seconds
 Timing error display
 A. error bar
 25. display switch
 "M" - memory
 "C" - time from the HHT clock

hundreds). There are a total of nine digits used to display the time; eight of these can be set with the controls in the HHT internal clock control region (unit seconds cannot be so controlled). When memory is displayed, the recording parameters of one program window are displayed. The numerical duration code is the most significant digit in the left display; the two less significant digits are the two least significant digits of the Julian day (ie. tens and units). The most significant Julian day digit (hundreds) is not used. The center display shows the hours and minutes separated by colons. Because the program window contains no seconds, this portion of the display is blank.

Whenever the 48-wire cable connects the HHT to a master clock or an SCR, the time difference between the internal clocks is shown on the right liquid crystal display (timing-error display). The timing-error display shows a signed value in the range ± 399.9 ms. It is therefore possible to synchronize the millisecond values from both clocks so that a ± 0.1 ms value appears in the timing error display, but that the seconds, minutes, hours, and days are not synchronized. For this reason, an error bar in the top left corner of the timing-error display flashes if any portion of the time is not synchronized (on some HHT's the word "BAT" flashes). The error bar does not flash until the timing error display shows less than a 1-ms error. For timing errors less than 400 milliseconds, the sign indicates whether the remote clock (master clock or SCR clock) is faster or slower than the HHT clock. If the sign is negative the remote clock is behind the HHT clock otherwise the remote clock is ahead of the HHT clock. The SCR clock can be adjusted with the controls in the SCR remote control region. The master clocks cannot be controlled from this region. The legend of Figure 2.7 lists which switches control the remote functions.

The memory region contains the thumb wheels used to program the HHT memory and the controls for programming and verifying the HHT and SCR memories. Controls for setting and adjusting the HHT clock are in the HHT internal clock control region. The general functions region contains the I/O connector, the battery recharger connector, a monitor switch, and four test points. The monitor switch controls which SCR function is being monitored through test points A and B. Table 2.3 lists the functions monitored at each position of the monitor switch.

SCR

The SCR's control interface, located in the clean outer compartment contains attenuation controls, a clock display, clock controls, test points, and a tape deck port (Figure 2.8).

Table 2.3

HHT MONITOR SWITCH POSITIONS

TEST POINT A

- 1 Amplifier from channel 1
- 2 Amplifier from channel 2
- 3 Amplifier from channel 3
- 4 not used
- 5 not used
- 6 not used
- 7 1 Hz signal derived from SCR clock
- 8 WWVB D.C. voltage level (not currently used)
- 9 Voltage from SCR battery
- 10 Power supply card +5 V regulated
- 11 Multiplexed signal from FSK (frequency shift key) board
- 12 Voltage from HHT battery

TEST POINT B

- 1 Modulated VCO signal from channel 1
- 2 Modulated VCO signal from channel 2
- 3 Modulated VCO signal from channel 3
- 4 not used
- 5 not used
- 6 not used
- 7 IRIG E signal derived from SCR clock
- 8 WWVB time code output (not currently used)
- 9 Voltage received by SCR record board and tape deck
- 10 Power supply card -5 V regulated
- 11 multiplexed signal to the record amplifier board
- 12 not used

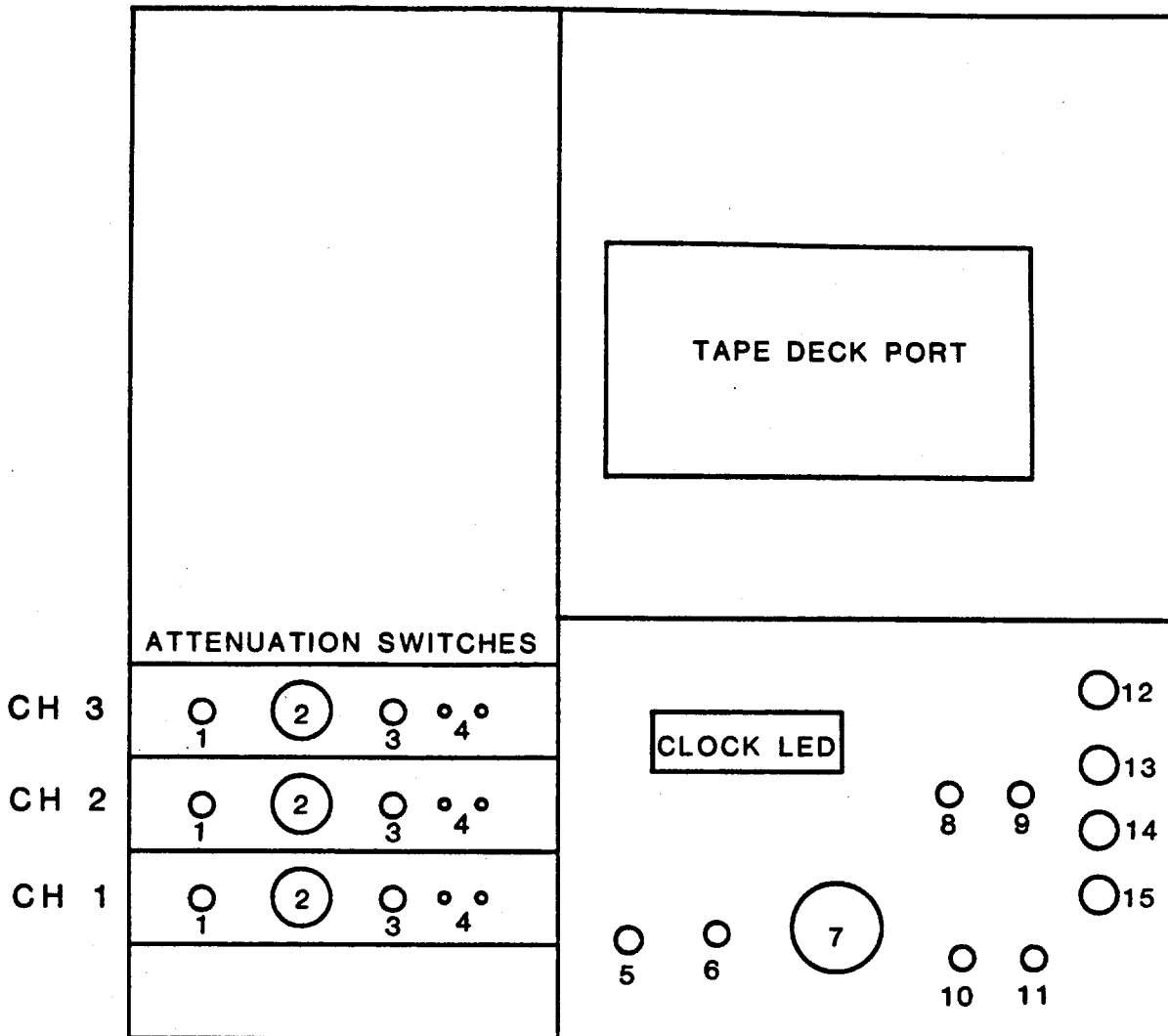

Figure 2.8. SCR user interface.

- | | |
|--------------------------------|--|
| 1. Test point for amplifier | 9. Reset button |
| 2. Variable Attenuation switch | 10. ADV/RET switch |
| 3. Attenuation toggle switch | 11. Rate switch |
| 4. Test points for FM carrier | 12. Test point for time code |
| 5. Display ON/OFF switch | 13. Test point for 1 Hz signal |
| 6. Set button | 14. Input point for starting the clock automatically |
| 7. Time division switch | 15. Test point ground |
| 8. RUN/HOLD switch | |

PROGRAMMING PROCEDURES BEFORE DEPLOYMENT

Before programming, obtain blue and white data sheets and a copy of the program times and attenuation settings for that deployment. Unwrap and label the cassette tapes with the SCR serial number, the experiment name and year, and the deployment number, and wind the tape to the end of the clear leader. Then determine which master (reference) clock to use and program the HHT as described next.

Programming the HHT

To program the HHT, enter the recording parameters of all program windows into the HHT memory and synchronize the HHT internal clock with the master clock. After the HHT is programmed, record the GMT time of clock synchronization in the HHT section of the white data sheets. Then proceed to program each of the SCRs.

Memory

To enter recording parameters for the ten program windows into the HHT memory, position the memory select switch to "HHT" and push the memory reset button. For each set of recording parameters, set the thumb wheels with the recording duration code in the leftmost wheel followed by the turn on time (TD, UD, TH, UH, TM, UM); then press the memory-enter button. After ten such entries have been programmed, the memory select switch should be set to the "REC" (i.e. SCR) position. The windows may be checked by positioning the display switch to the memory position ("M") and pushing the memory reset button. Repeatedly pressing the memory enter button will step through the sequence of programmed windows. As the enter button is pushed, each window will be displayed and after the tenth window, the sequence will repeat. Note that the memory select switch should normally be in the "REC" position so that accidental modification of the HHT memory does not occur.

Synchronizing the internal clock

Controls from the HHT internal clock control region of the user interface (Figure 2.7) are used to set and synchronize the HHT internal clock with a master clock. The synchronization process begins by visually comparing the display of the HHT with the display of the master clock. If the HHT and the master clock are not synchronized, the HHT internal clock must be reset. There are two procedures to set the HHT clock -- a manual procedure and an automatic procedure (both are described next).

If the HHT clock is more than 400 ms different from the master clock, reset the HHT clock manually or automatically. In both cases, to set the HHT internal clock, move the run/hold switch to the hold position and press the reset button. Allowing enough time to set all eight time divisions, choose the time at which you intend to restart the clock. Normally 30-50 seconds ahead of the master clock (reference) time is sufficient, but during the first

few attempts, the time chosen should be 2 minutes ahead of the master clock time. Set the HHT clock to this time by moving the switch which selects time divisions to the "TS" position and then pushing the set button repeatedly until the desired number appears on the display in the tens of seconds position. Then move the time division switch to the "UM" position and again set the time by repeatedly pushing the set button until the desired number appears in the units of minutes position. In like manner, set all the other time divisions (note that a one appears in the UD position after the display has been reset). After the chosen time is set, restart the clock manually or automatically.

To restart the clock manually, prepare to move the run/hold switch to the run position then watch the display of the master clock. When the chosen time appears on the master clock display, immediately move the run/hold switch to the run position. Confirm the clock is set correctly by visually comparing the time display of the HHT and the master clock. If the displays differ repeat this section. Finally, synchronize the HHT clock as described later.

To restart the clock automatically, set the "start minute" thumb wheel on the master clock to the minute chosen to start the HHT clock. Move the run/hold switch to the center position and attach the 48-wire cable to the I/O connectors in the HHT and the master clock. The HHT clock will start at the chosen minute. Then move the run/hold switch to the run position and correct any remaining time difference as described next.

If, as is most often the case, the HHT clock does not need to be set, connect one side of the 48-wire cable to the I/O connector on the HHT and connect the other side of the cable to the I/O connector on the master clock. The time difference between the two clocks may now be read from the timing error display on the HHT. If the timing error displayed is more than 10 milliseconds, hold the rate switch in the 100 ms/s position and move the ADV/RET switch to advance or retard the HHT clock. At this speed the clock changes quickly, so movements of the ADV/RET switch should be brief. When the timing error approaches 10 milliseconds, the rate switch should be moved to the 1 ms/s position and the ADV/RET switch held in position until the error approaches + 1 ms. Thereafter movements of the ADV/RET switch should be brief until a timing error of + 0.1 ms is displayed. If the error bar starts flashing when the timing error falls below 1 ms and does not stop flashing within 20 seconds, compare the displays of the HHT and the master clock and then resynchronize the HHT (the error most often is one second). After the HHT has been programmed, start programming the SCRs.

Programming the SCR

To program an SCR, attach the 48-wire cable to the I/O connector on the HHT interface panel and to the I/O connector in the "dirty" compartment of the SCR. Load the SCR memory and synchronize the SCR internal clock with the HHT internal clock as described below. Lastly, set the attenuation switches and place the cassette tapes in the tape deck port.

Memory

To load the SCR memory, position the HHT memory select switch to "REC", press the memory reset button and then push the "auto load" button. This procedure enters all ten program windows into the SCR's memory. In order to verify the contents of the SCR's memory, move the display switch to the "M" position and with the memory select switch still on "REC" press the reset button. Now toggle the memory select switch. Each time this switch is moved to the "HHT" position, a new SCR program window will be displayed. After the tenth window is displayed, the first window will appear again. Continued toggling will repeat the cycle.

Synchronizing the SCR internal clock

To synchronize the SCR internal clock with the HHT's internal clock, move the HHT display switch to the "C" position and visually compare the HHT display with the SCR display. If the two clocks do not agree, reset the SCR's internal clock using the controls in the clean compartment of the SCR. Proceed as described above for manually resetting the HHT's internal clock but in this case, reset the SCR clock and not the HHT clock. When the two displays agree, use the clock adjustment switches in the "SCR remote control region" of the HHT to correct any fractional second SCR clock error. If the SCR clock error is greater than 10 ms hold the rate switch in the 100 ms/s position and use the ADV/RET switch to reduce the time difference to within 10 ms. For smaller adjustments, position the rate switch to 1 ms/s and push the ADV/RET switch to advance or retard the SCR clock. If the error bar starts flashing when the timing error falls below 1 ms, compare the displays of the HHT and the SCR. If the displays are the same, let the SCR stabilize. Ten seconds after the next minute mark the error bar should turn off. If the displays differ (commonly in the unit seconds time division), resynchronize the SCR clock. After the SCR clock has been synchronized, record the GMT time on the white sheet.

The adjustment switches in the "clean" compartment of the SCR may be used to correct the timing error in place of the controls in the HHT remote control region. Some people prefer this method because it precludes accidentally changing the HHT's clock to match the clock in the SCR!

Attenuations and cassette tape

To set the attenuation, open the clean compartment of the SCR. There are two attenuation switches per data channel and the sum of their values is the total attenuation value for that channel. For example, if the variable switch is set to 48 and the toggle switch is set to 20, then the total attenuation is 68 db for that channel. From top to bottom, the channels are 3, 2, and 1 (Figure 2.8). Set the attenuation switches to the settings designated for this unit. Normally, the lowest attenuation (highest gain) is channel 2 and the highest attenuation (lowest gain) is on channel 3.

Place a cassette tape in the tape deck port so that the unused tape is

spooled on the left spindle. Tap the tape gently to ensure proper seating. Each tape should be labeled with the SCR number, the experiment name and year, and the deployment number. Finally, record the attenuation settings on the blue sheet. Then proceed to the next SCR.

After the last SCR has been programmed, compare the HHT clock to the master clock and record on the white sheet the drift of the HHT clock during programming. Then connect the battery charger and recharge the SCR batteries.

Charging the SCR Batteries

The batteries should be recharged prior to deployment of the SCRs. To recharge the batteries, connect each of the SCRs and the HHT to the 2-wire cables and check the connection between the resistor bank and the power supply. Then turn on the power supply and position the voltage level output to 14.9 V. Last, check the charging rate of each SCR by measuring the voltage drop across each resistor. If the SCR's have not been on high charge, they will draw current which will result in a voltage drop greater than 0.9 V. A voltage drop close to zero usually implies a bad connection and should be reported immediately to maintenance personnel. A fully charged SCR gives a voltage drop of 0.20 V to 0.50 V.

PROCEDURE AFTER RETRIEVAL OF THE SCR'S

After the SCR's have been retrieved their internal clock drifts must be recorded on the white sheets, the batteries recharged, and malfunctioning instruments identified from playbacks of the diagnostic tests recorded on each tape (playback procedures are not discussed here).

Recording drift times

To record the drift times after the SCRs have been retrieved, synchronize the HHT internal clock with the master clock as described above. Attach the 48-wire cable to each SCR and record both the GMT time and the drift on the white data sheets. After all the SCR drifts have been recorded, compare the HHT to the master clock and record the drift of the HHT clock while the SCR drifts were measured.

MISCELLANEOUS HHT FEATURES

In addition to programming, the HHT provides a means of monitoring the SCR internal electronics at various stages (Table 2.3) and provides external control of the tape deck. To control the SCR tape recorder, first, turn on the SCR "VCO" power then the SCR "REC" power. Now, the tape recorder can be controlled from the SCR remote control region of the HHT. If the cassette tape is locked in the tape deck port, turning on the "VCO" power switch and then the "REC" power switch will cause the locking bar to retract.

ACKNOWLEDGMENTS

The author would like to express her appreciation to John VanShaack, Gray Jensen, Will Kohler, Bob McClearn, and to Ron Kaderabek for their assistance and detained explanations of the recording unit and the digitizing unit. Also, appreciated are comments from Tom Brocher, Bob Colburn, Phil Dawson, Jim Luetgert, Rob Luzitano, Jill McCarthy, and Allan Walter and reviews by John VanShaack and John Evans.

REFERENCES

- Dawson, P.B., Stauber, D.A., 1986, Data report for a three-dimensional high-resolution P-velocity structure investigation of the Summit Caldera of Newberry Volcano, Oregon, using seismic tomography: U.S. Geological Survey Open-file Report 86-352.
- Dratler, J., 1980, Theoretical transfer functions for stations in the Central California seismographic network: U.S. Geological Survey Open-file Report 80-376.
- Eaton, J.P., 1975, Harmonic magnification of the complete telemetered seismic system, from seismometer to film viewer screen: U.S. Geological Survey Open-file Report.
- Eaton, J.P., 1977, Frequency response of the USGS short period telemetered seismic system and its suitability for network studies of local earthquakes: U.S. Geological Survey Open-file Report 77-844.
- Healy, J.H., 1977 and O'Neill, M.E., Calibration of seismographic systems: USGS stations in the Central California network: U.S. Geological Survey Open-file Report 77-736.
- Healy, J.H., Mooney, W.D., Blank, H.R., Gettings, M.E., Kohler, W.M., Lamson, R.J., Leone, L.E., 1982, Saudi Arabian seismic deep-refraction profile: final report: U.S. Geological Survey Open-File Report USGS-OF-02-37, 141 pp.
- Stewart, S.W., and O'Neill, M.E., 1980, Calculation of the frequency response of the USGS telemetered short-period seismic system: U.S. Geological Survey Open-file Report 80-143.

Appendix A: A decoded example of the IRIG-E time code.

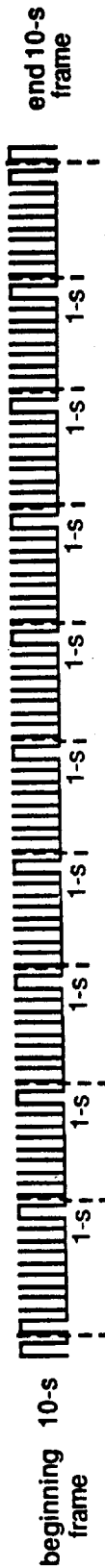

A.) Ten second time code frame.

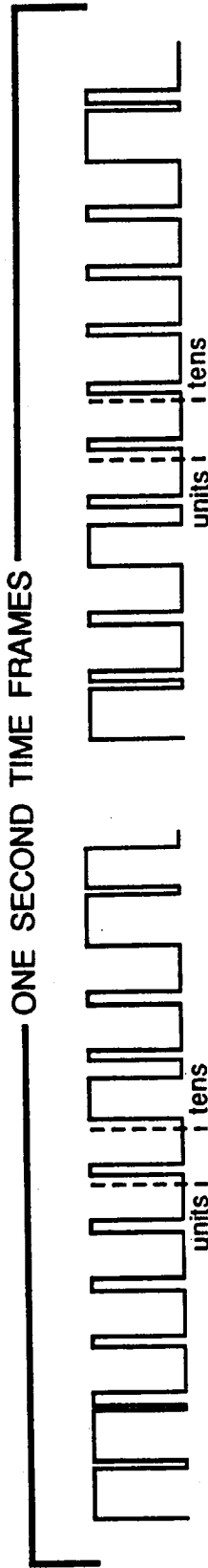

B.) First 1-s time frame represents seconds.

E.) Fourth 1-s time frame represents units and tens of the 3-digit Julian date.

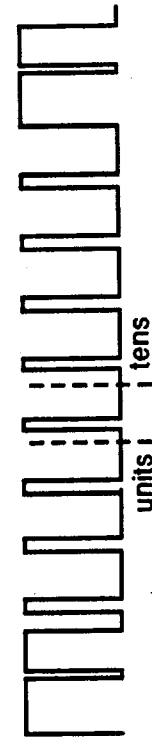

C.) Second 1-s time frame represents minutes.

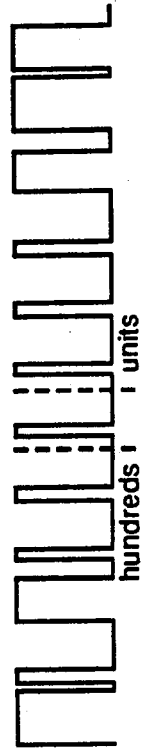

F.) Fifth 1-s time frame represents hundreds of 3-digit Julian date and units of the 3-digit recorder serial number.

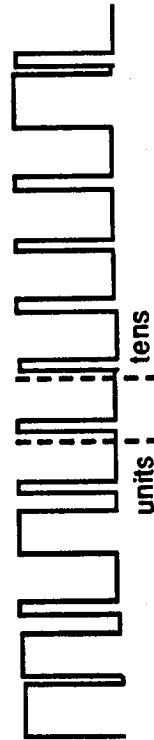

D.) Third 1-s time frame represents hours.

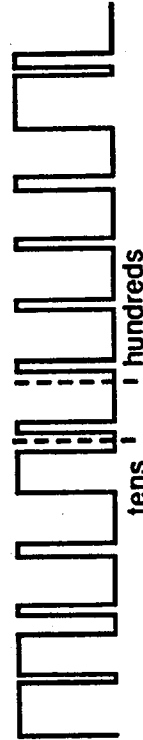

G.) Sixth 1-s time frame represents tens and hundreds of the 3-digit recorder serial number.

Figure 1.11. IRIG-E time code.